

Field evaluations in Taiwan of the DVB-T COFDM and ATSC 8-VSB digital TV systems

Chi-Fang Huang, The Nan Chang and Chau-Yun Hsu

Graduate Institute of Communication Engineering, Tatung University, Taiwan

This article presents the results of field evaluations carried out in Taiwan on the two principal digital TV broadcasting systems in use today – ATSC 8-VSB (developed in North America) and DVB-T COFDM (developed in Europe). The evaluations were carried out in February and March 2001 in the Northern area and the Taipei metropolis of Taiwan.

Based on the subsequent report (which forms the basis for this article), the Taiwan telecommunications authority agreed to deregulate DTV broadcasting and adopt the DVB-T transmission standard. DVB-T is now being used by the five terrestrial television broadcasters in Taiwan.

With most segments of the electronics industry “going digital” in the late 1990s, the Taiwan government became very aggressive in promoting the digitalization of terrestrial television broadcasting on the island. The government’s views were that the promotion of digital terrestrial television (DTT) would bring considerable economic strength to Taiwan. Thus, in 1998, it announced that the North American ATSC transmission standard would be adopted, and it scheduled the start of engineering tests for July 1999. Furthermore, the government declared that all DTT stations should be in service by December 2001. The existing analogue NTSC transmissions should co-exist with the new digital transmissions for a further five years and, when the expected digital coverage had reached 85% of the population, the analogue transmission licences should be terminated.

At the time, the countries that were proposing to adopt the ATSC 8-VSB system were the USA, Canada, South Korea and Argentina [1].

In 1999, Sinclair Broadcasting demonstrated COFDM and 8-VSB reception to broadcasters in Baltimore (USA). These demonstrations raised deep concerns worldwide about the performance of the ATSC 8-VSB system when compared with the European DVB-T COFDM system:

- COFDM was found to be more capable of handling the multipath signal propagation that often occurs in city (and hilly or mountainous) areas;
- The DVB-T system worked very well with a simple indoor antenna, unlike the ATSC system which often required an external directional yagi antenna.

- Mobile reception – which had been seen by the broadcasting companies as a new business opportunity, especially when data broadcasting is added – was considered to be a viable option of the DVB-T system. This point is very important for those countries, such as Taiwan, where cable TV penetration is dominant.

The Taiwanese evaluations of ATSC and DVB-T

A Taiwanese project – sponsored by The Television Academy of Arts & Sciences of the Republic of China – was set up to carry out local evaluations of the **ATSC 8-VSB** and **DVB-T COFDM** systems [2]. The areas chosen for these measurement tests were Northern Taiwan and the Taipei Metropolis. And the reception modes to be considered were:

- 1) outdoor fixed-point reception (at 102 receiving locations);
- 2) outdoor mobile reception (along twelve highways and streets);
- 3) indoor fixed-point reception (at 103 receiving locations inside seven buildings).

The data collected from these locations and routes was considered to be adequate to satisfy the project's aims. In accordance with the existing NTSC spectrum allocation in Taiwan, the channel width for the digital tests was set at 6 MHz for both systems. The modulation parameters used for the evaluations are shown in *Table 1*:

Table 1
Modulation parameters to be measured

Reception mode	ATSC	DVB-T
Outdoor fixed-point reception	8-VSB	QPSK:64-QAM / 8k FFT
Outdoor mobile reception	8-VSB	QPSK:16-QAM / 2k FFT
Indoor fixed-point reception	8-VSB	QPSK:64-QAM / 8k FFT

The transmitting antenna was installed at the CTS (Chinese Television System) station on the Yang-Ming-Shan mountain (*see Fig. 1 – left*). It had the following characteristics:

- RFS dipole array;
- Frequency = 593 MHz;

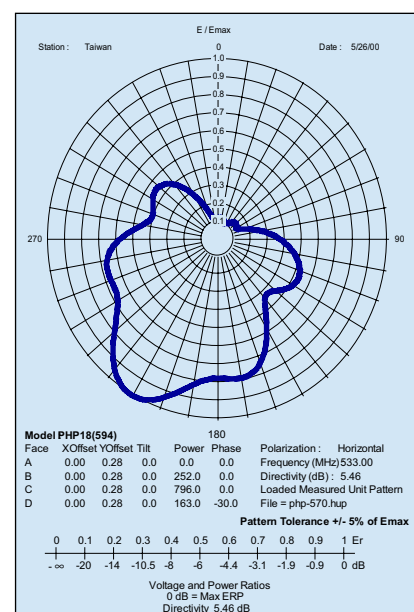

Figure 1
RFS dipole array for DTV transmitter: (*left*) location and (*right*) simulated radiation pattern

- Power at the antenna input = 5 KW;
- Polarization = horizontal (HP).

The simulated radiation pattern offered by the RFS antenna is shown in *Fig. 1 – right*. The 0° axis is directed to the north.

The results of these evaluations were then presented to the Directorate General of Telecommunications, Taiwan – representing the broadcasters' proposal for DTT in the spirit of telecommunication deregulation. The proposal was accepted and, in mid-2001, the DVB-T transmission standard for terrestrial television was adopted by the five terrestrial broadcasters in Taiwan.

Outdoor fixed-point reception

Many reports have been published [1] on the results of evaluation tests carried out on DVB-T COFDM and ATSC 8-VSB in a number of countries or areas. As a result, experts have gained some understanding of the characteristic differences between these two systems. However, the evaluation project described here was a locality-oriented one to test the potential performance differences between these two systems in parts of Taiwan. The test areas used included a mountainous region as well as an urban residential area containing not only small houses but high apartment blocks as well.

Since this was a comparison test, the output power of the transmitter was set at 5 KW. The reception measuring system is shown in *Fig. 2*. This equipment was installed in a Harries vehicle (*see Fig. 3*).

The receiving antenna (*see Fig. 4 – left*) was a log-periodic, horizontally polarized (HP), covering the range from 200 MHz to 1 GHz. Its radiation pattern is shown in *Fig. 4 – right*, which was measured in the anechoic chamber of Tatung University. The pattern shown was measured at 593 MHz using horizontal polarization.

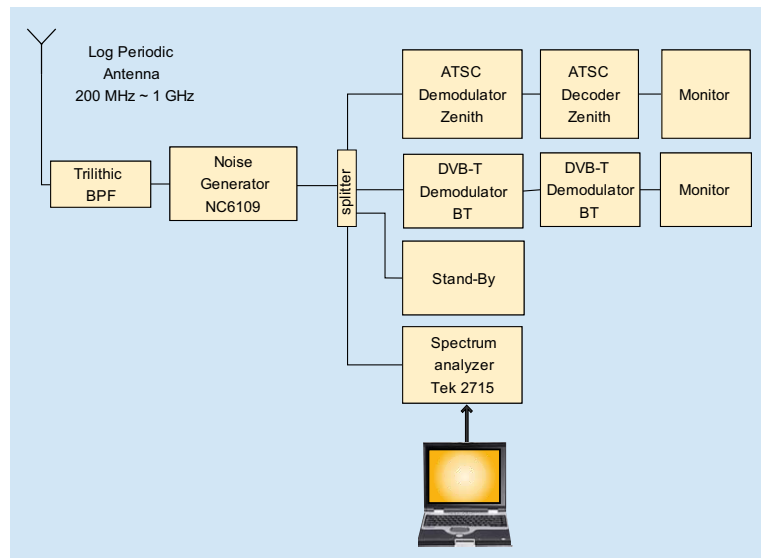

Figure 2
Schematic of the reception measuring system



Figure 3
The measurement vehicle



Figure 4
(left) the log-periodic antenna that was used and (right) its measured radiation pattern at 593 MHz, HP

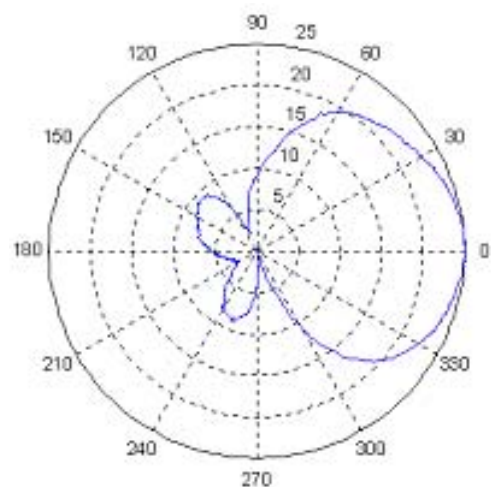

When receiving the DTT signals, the antenna was raised to a height of 8.1m above ground level and was rotated to find the direction of best reception. The antenna direction was duly noted. The incoming signals were routed through a band-pass filter of 593 MHz centre frequency and 78 MHz bandwidth. The band-pass filter was included to reject ambient background noise from the considerations. A noise generator was also included in the antenna feed to simulate multipath interference in the surrounding environment. A measurement parameter that we used during the tests is the Threshold of Visibility (S/N@TOV) which is explained later. At each measurement point, background noise from the generator was added at the weakest level and was then progressively increased to determine the S/N@TOV value.

Finally, the composite RF signal was fed into a splitter and divided further into four paths – one for the ATSC 8-VSB demodulator, one for the DVB-T COFDM demodulator, one for a spectrum analyzer, and a spare feed. The professional demodulators and decoders used by the two systems are listed below:

ATSC receiver:

Demodulator: Zenith DTVDEMOS-S
Decoder: Zenith DTVDECODER-H

DVB-T receiver:

Demodulator: BT DTVM2000(T)
Decoder: BT DTVD-200

[BT: Broadcasting Technology Ltd.]

Video monitors were used for displaying the broadcast programmes and for evaluating the picture quality using the CCIR 5-point grading scale (0 – 4). If the DTT signals were good, they produced traces on the spectrum analyzer as shown in *Fig. 5*.

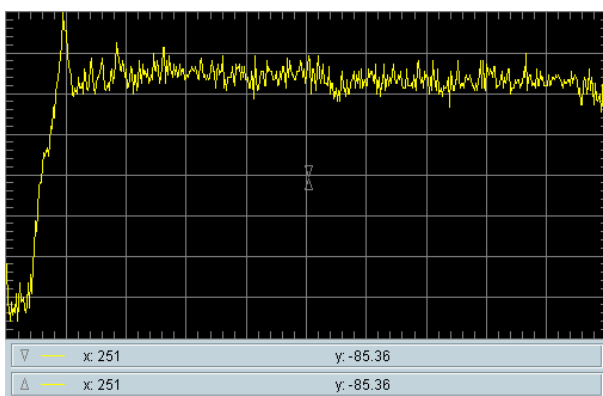

(a)

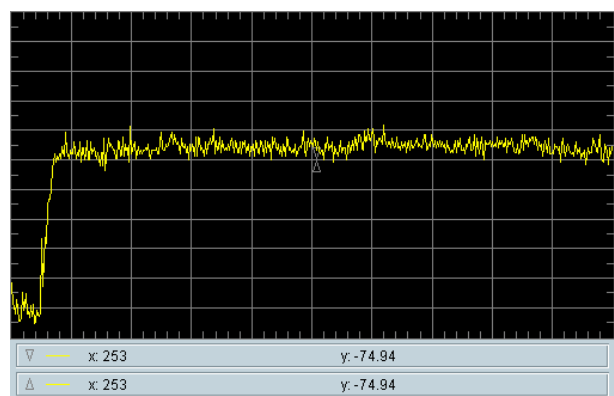

(b)

Figure 5

Spectrum trace under good reception conditions: (a) ATSC spectrum; (b) DVB-T spectrum



Figure 6

Distribution of the measurement points

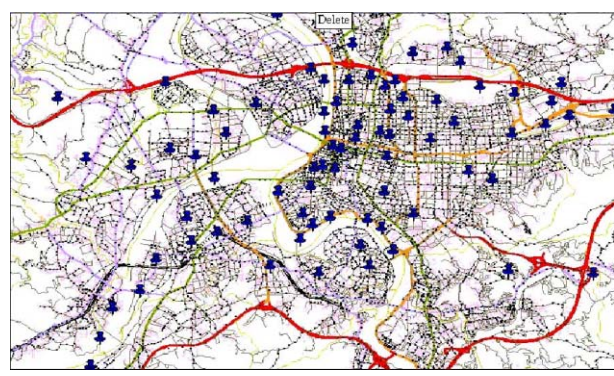

Figure 7

Distribution of the measurement points near Tapei city

The spectrum analyzer was controlled by a notebook PC through a PCMCIA interface. At each outdoor fixed location, the measurements were carried out separately on the two systems: via a radio link, staff at the transmitting station were instructed to switch between the two systems. In addition to providing the visual traces, the spectrum analyzer calculated the field strength (E) of the incoming RF signal and its average power within the channel.

A total of 102 locations were used for the outdoor fixed-point measurements. Geographically, the most southerly point was at Hsin-Pu and the most northeasterly point was at Pa-Du. The location coordinates were recorded by a GPS receiver. Furthermore, these coordinates were fed into a software called MapInfo [3] to be “sprinkled” onto a map as shown in *Fig. 6*. An enlarged view showing the measurement points near Taipei city is given in *Fig. 7*.

Measured point:	Lin An-Tai Old House	Best receiving direction:	5° ETN (see Abbreviations)
DTT system	ATSC	DVB-T (mode 1: 8k)	Spectrum
E (dB μ V/m)	42.2	42.1	Upper: ATSC Lower: DVB-T
Average power (dBm)	-77.1	-77.2	
S/N (dB)	15.5	21.68	
S/N@TOV (dB)	13.6	18.92	
Site Margin (dB)	1.9	2.76	
Tap energy (dB)	-17.1		
SER	0		
MER		21.66	
BER		1.67E-02	
CCIR Grading	4	4	

Figure 8
Record table for the measurements made at each outdoor point

Referring to *Fig. 8*, which is a record table of the measurements made at each outdoor point, the items on it can be explained as follows (the second entry of the first row is the location name):

- The best receiving direction – the fourth entry of the first row – found by rotating the receiving antenna.
- E field – the field strength of the RF signal, defined as mentioned above
- Average Power – calculated from the spectrum analyzer by a software application.
- S/N (dB) – after demodulation, this is the Signal-to-Noise ratio of the decoder before decoding [4], and it may be viewed as “the ideal signal compared to everything else”. Taking the 8-VSB system as an example, the S/N may be defined as:

$$S / N = 20 \log \left[\frac{\sqrt{\frac{1}{N} \sum_{j=1}^N I_j^2}}{\sqrt{\frac{1}{N} \sum_{j=1}^N \delta I_j^2}} \right] \quad (dB)$$

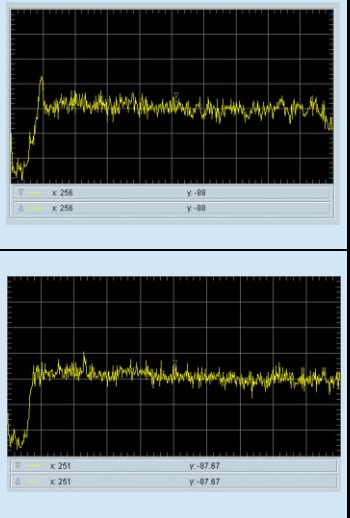
where,

I_j is the ideal in-phase or real axis symbol value, transmitted during the j^{th} interval,

δI_j is the difference along the real axis between the ideal signal value and the value actually received during the j^{th} interval.

In the 8-VSB system, there are seven kinds of source errors or noise which can affect the S/N value. They are: Frequency response error, Group delay error, Amplitude error, Phase error, Phase noise, Broadband noise and Software (DSP) noise. As a result of using different demodulation and decoding mechanisms, the S/N values shown on *Fig. 8* are different, even if the RF field strength is more or less the same.

- e) S/N@TOV (dB) – after receiving the best picture quality on the video monitor, the noise generator begins to increase the noise level until the picture cannot be displayed normally any more; for example, mosaic patterning or frame stopping begins to happen. At this point, reception reaches the so-called TOV (Threshold of Visibility). At this moment, the S/N value of the decoder is referred to as S/N@TOV.
- f) Site Margin (dB) – value of the “d term” above (i.e. S/N) minus the value of the “e term” (S/N@TOV). It represents the dynamic range of the system’s ability to withstand environmental noise.
- g) Tap energy – this term and the following one are special parameters used in the ATSC 8-VSB system. Its value is obtained by dividing the amplitude of the interfering multipath signal with the amplitude of the main wanted signal. It is read out from a chart that is displayed by the decoder software. Hence, the larger the value of the Tap energy, the stronger is the interfering multipath signal.
- h) SER – Segment Error Ratio.
- i) MER – Modulus Error Ratio. This term and the following one are special parameters used in the DVB-T COFDM system.

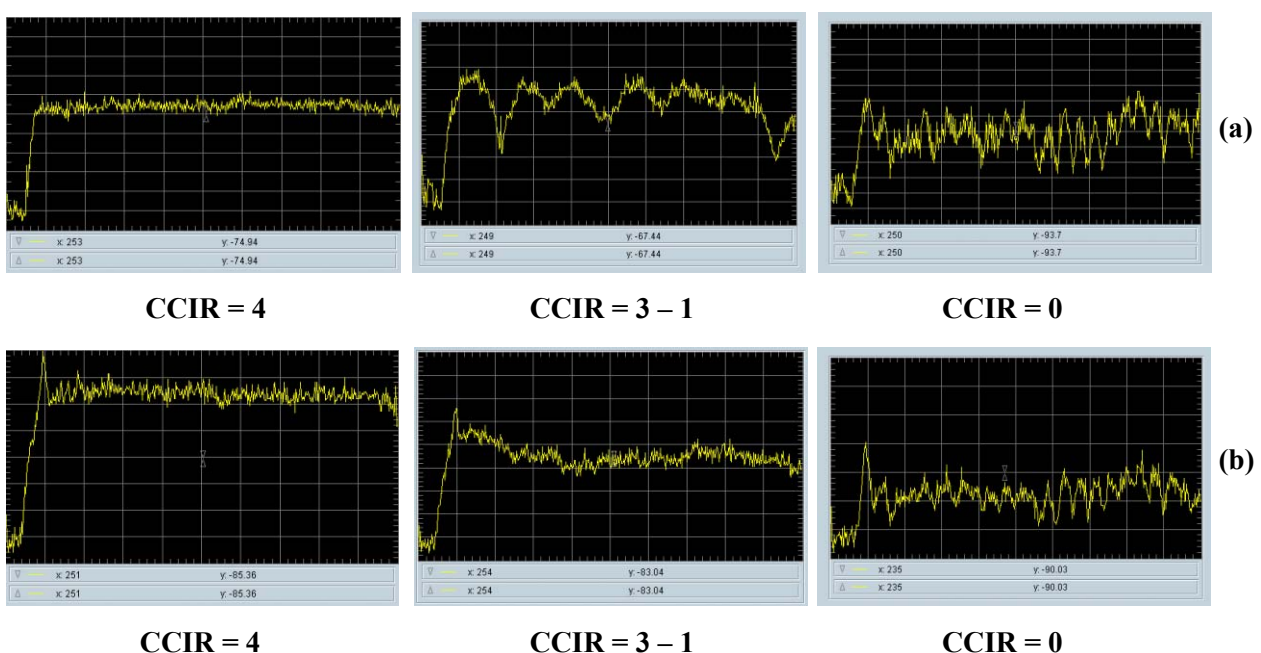

Figure 9
Received spectra of (a) DVB-T programmes (b) ATSC programmes

- j) BER – Bit Error Ratio
- k) CCIR Grading – by definition, the perfect picture is classified with a grade of < 5 >. It is classified as grade < 0 > when no picture at all is displayed. In our measurements, grade < 5 > was not adopted; a normal received picture was classified as grade < 4 >. Other abnormal pictures were given a grade between < 1 > and < 3 >, as judged by the tester. *Fig. 9* shows the spectrum traces for different CCIR grades in the case of the two DTT systems under test.

The detailed results obtained at each location have been well documented in the project's final report [5]. *Table 2* compares the statistical results of the two systems, based on their CCIR gradings.

Table 2
Statistical results of outdoor receptions at 102 locations

CCIR Grade	ATSC	DVB-T
4	53	58
3	5	4
2	5	2
1	6	8
0	33	30

Measured point:	Crossing of Fu-Hsin N. Rd. and Ming-Sheng E. Rd.	Best receiving direction:	330° ETN (see Abbreviations)
DTT system	ATSC	DVB-T (mode 1: 8k)	Spectrum
E (dBμV/m)	70.6 [Amp: +20dB]	70.5 [Amp: +20dB]	Upper: ATSC Lower: DVB-T
Average power (dBm)	-48.7	-48.8	
S/N (dB)	3.4	21.4765	
S/N@TOV (dB)	N/A	N/A	
Site Margin (dB)	N/A	N/A	
Tap energy (dB)	-2.6		
SER	12852		
MER		21.468	
BER		1.67E-02	
CCIR Grading	0	1	

Figure 10
An example of no reception in a high field-strength area

Over the whole area, DVB-T was observed to provide better reception than ATSC. There were only two points where reception of ATSC was graded as $\langle 4 \rangle$ while DVB-T only attained a $\langle 3 \rangle$. This occurred in low field-strength areas. The measured field strengths, ATSC vs. DVB-T, were $\langle E = 46.1 \text{ vs. } 46.7 \text{ dB}\mu\text{V/m} \rangle$ and $\langle E = 46.6 \text{ vs. } 46.5 \text{ dB}\mu\text{V/m} \rangle$.

When all 102 reception points are considered, the lowest field strengths which yielded CCIR grades of $\langle 4 \rangle$ were at the following locations:

- **ATSC** – Lin An-Tai Old House [N 25° 04' 24"; E 121° 31' 18"], $E_{\min} = 42.2 \text{ dB}\mu\text{V/m}$;
- **DVB-T** – Hsin-Hai roadside gate [N 25° 01' 22"; E 121° 32' 10"] of Taiwan University, $E_{\min} = 41.9 \text{ dB}\mu\text{V/m}$.

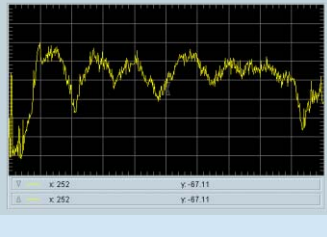
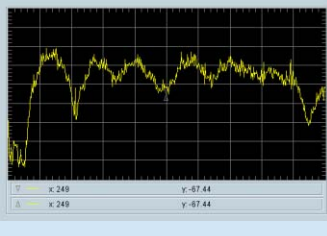
Consequently, it is not easy to find a simple explanation for obtaining such a high subjective grading despite the low field strengths (close to the E_{\min} value). On the other hand, there were some locations where the field strength was well above the E_{\min} value – yet, even with the assistance of a 20 dB gain RF amplifier, the pictures still failed (the channel spectrum may have been seriously impaired). The record shown in *Fig. 10* is an example. This evidence demonstrates that a high field strength is not always able to guarantee successful reception, and this is in contrast to traditional analogue TV broadcasting.

For the purpose of analyzing the capabilities of these two different transmission systems in the presence of multipath signals, the term “Site Margin” is used. As a whole, the value of this term in DVB-T reception is larger than that in ATSC. For instance, at the Sung-Shan airport location [N 25° 03' 51"; E 121° 32' 39"], the Site Margin values were 8.47 dB vs. 1.7 dB. Obviously, the COFDM functions very well in this situation.

It must also be noted that many of the locations tested did not yield usable pictures, mainly due to building clutter in the urban areas: these measurement points were graded $\langle 0 \rangle$.

Outdoor mobile reception

A key factor we considered was the capability of both systems in the mobile environment. For this part of the evaluation, the vehicle shown in *Fig. 3* was employed as the “mobile receiver”. Since it was not possible to record the real-time instant parameters of the demodulator and decoder in a moving vehicle, the original ports from the splitter were respectively fed to a Panasonic ATSC set-top box (TU-DST50W) and a Hitop [6] DVB-T set-top box. The outputs were further fed to a VHS tape recorder to provide dynamic documentation of the results.

Additionally, the port which was connected to the spectrum analyzer was, for these tests, linked to an FSS (Field Survey System) receiver – the GPR4427A receiver from CHASE Communications [7]. This system is assisted by a GPS receiver, such that the position data and the corresponding field strength can be measured and recorded simultaneously. During mobile reception, it was impossible for the receiving system to predict the incoming wave direction and, therefore, it was not possible to use the directional wide-band log-periodic antenna. Instead, we used a Maxview [8] omni-directional antenna designed for horizontal polarization (*see Fig. 11 – left*), which we installed on the vehicle roof. *Fig. 11 – right* shows its omni-directional radiation pattern at 593 MHz (again measured at Tatung University). This antenna is “active” in that it provides 20 dB of RF gain.

In total, we measured reception along twelve highways and streets in this evaluation of mobile reception. Some of these routes lie in a north-south direction and others lie in an east-west direction. By using MapInfo’s pseudo-colour facility for field-strength illustration purposes, maps similar to *Fig. 12 – left* could be created.

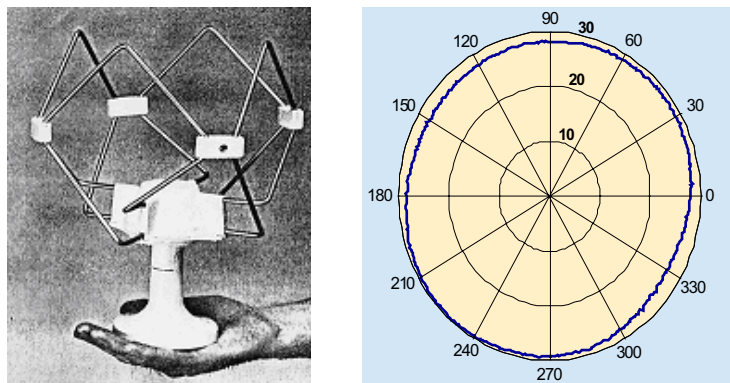

Figure 11
(left) Maxview's omni-directional antenna and (right) its radiation pattern

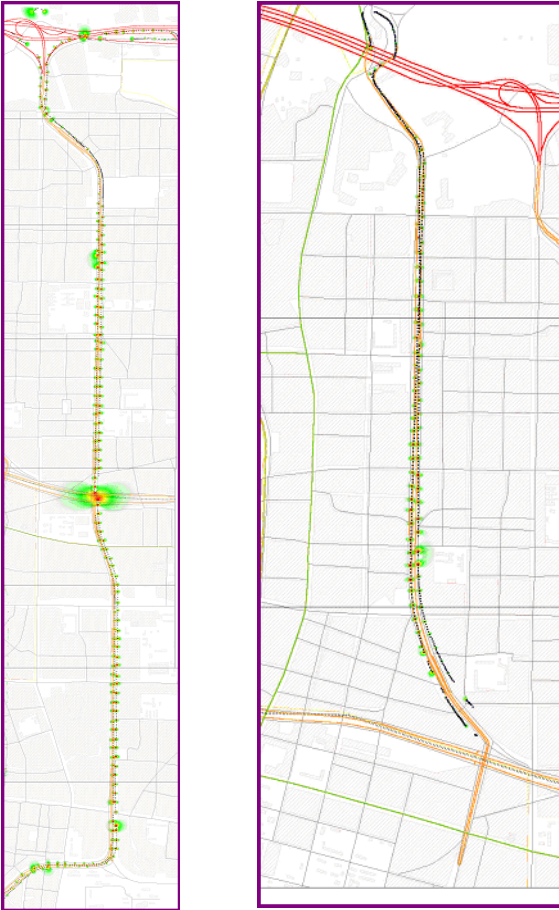

Figure 12
Mobile reception tested on (left) the Cheng-Kuo highway and (right) the Hsin-Shen highway

COFDM were recorded by the CHASE FSS. By attaching a triggering sensor on one of the vehicle's wheels, it was possible to set a distance interval – say every 50m or 100m – for acquiring the real-time data on the vehicle's

This map in fact shows the results of mobile reception along the Cheng-Kuo highway which runs north-south and is the main express highway through downtown Taipei.

The DVB-T modulation mode was set to 2k/16-QAM for this session. However, for comparison purposes, further tests were carried out on another Hsin-Shen express highway in downtown Taipei. This time, in addition to 2k/16-QAM, we evaluated two other DVB-T modes: 2k/64-QAM and 8k/64-QAM. It came as no surprise that the high data-rate mode, 8k/64-QAM, is not so suitable for mobile reception. This judgment was based on real-time monitoring of the picture quality. *Fig. 12 – right* shows the pseudo-colour results produced by Mapinfo for this highway.

All the TV programmes monitored along these twelve highways and streets were video-taped. Furthermore, all the GPS/E-field data for ATSC 8-VSB and DVB-T

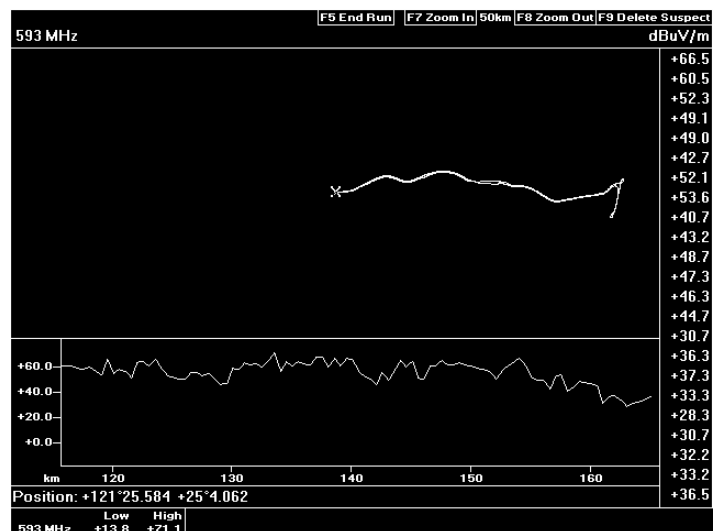

Figure 13
E-field strength and path data were recorded by a CHASE FSS receiver

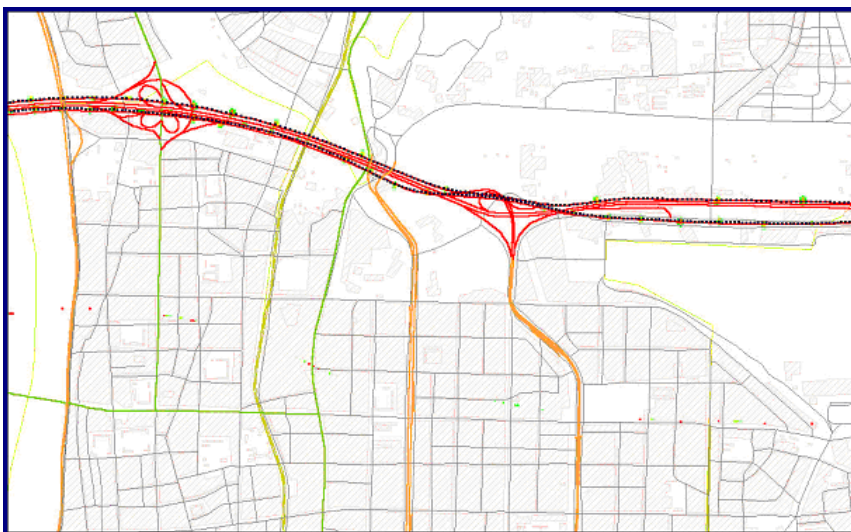

Figure 14
Mobile reception tested on the No. 1 freeway passing through Taipei city

location and the received field strength. The screenshot in *Fig. 13* shows an example of these data in which the corresponding E-field strength and the path data were recorded simultaneously. Additionally, during the reception procedure, the surroundings and car speed (as witnessed by the investigators) were recorded orally (synchronized with the picture video-taping).

Generally speaking, in these measurement comparisons, it was observed and may be concluded that mobile reception cannot truly be associated with the ATSC 8-VSB system. During most of the

reception tests, the displayed pictures were graded as $< 0 >$. On the other hand, mobile reception of DVB-T COFDM was very acceptable along large parts of the test routes but, on some sections, the pictures were interrupted quite often. It is presumed that the deployment of an SFN (Single Frequency Network) is essential if a reliable mobile service is to be achieved.

It was also observed with DVB-T that, if the high-speed data rate modulation is not applied, the influence of vehicle speed on the picture grading can be ignored. *Fig. 14* shows mobile reception along an east-west section of the Taiwan No. 1 freeway through Taipei city. Note that the small dots are the instantaneously measured reception points.

Indoor fixed-point reception

Many high buildings are located in the urban areas of Taiwan, and new “sky-scrapers” are going up all the time – such that terrestrial TV reception is becoming ever harder to obtain. With most people residing in apartments in these high buildings, the penetration of cable TV has almost reached 80% of the Taiwanese population. Any new terrestrial broadcasting service must therefore offer easy reception if it is to compete with the cable TV services.

In the tests on indoor fixed-point reception, the equipment set-up was the same as that used for the outdoor fixed-point reception tests, with the exception of the antenna. As during the mobile tests, the Maxview HP omni-directional antenna was used during the indoor tests. Consequently, during these measurements, the term “best receiving direction” was not taken into account. Based on the OFDM propagation characteristics, we found that an omni-directional antenna was preferred over a directional one.

We evaluated reception at 103 locations inside the seven buildings listed in *Table 3*.

Table 3
Buildings used for the indoor reception tests

Organizations	Measured locations	Labelling for the following text
Chinese Television System (CTS)	17	CTS
Taiwan Television Enterprise Ltd. (TTV)	14	TTV
China Television Company (CTV)	15	CTV
Formosa Television (FTV)	12	FTV
Sanlih E-Television Co., Ltd. (SET)	7	SET
The Directorate General of Telecommunications	21	DGT
Tatung Company	17	TATUNG

Table 4
Statistics of the measured results for indoor reception

CCIR Grade	ATSC	DVB-T
4	48	78
3	8	9
2	4	3
1	5	1
0	38	12

Table 4 shows the statistics of the measured results. In order to obtain satisfactory indoor reception, it seems that an LoS (Line of Sight) is not necessary. As a matter of fact, most of the measured indoor locations had no direct LoS towards the transmitter and, in many cases, the receiving antenna was not close to a window. That is why it was mentioned above that a directional antenna is not suitable for receiving the OFDM signals indoors.

It was conclusively shown that the DVB-T system is far superior to the ATSC system for indoor reception (see Table 4). However, it is much harder, than in the case of outdoor fixed reception, to explain all the observed phenomena. In particular, because of multipath factors, it is not easy to use the measured electric field strength data to predict the graded picture quality of these two systems. Among the 103 measured indoor locations, the lowest received field strength (E_{\min}) for a picture grading of $< 4 >$ was 47.5 dB μ V/m for ATSC (on the 3rd floor of TTV) and 43.6 dB μ V/m for DVB-T (in the ground-floor lobby of CTV).

In the following, we try to explain certain anomalies we found at some indoor locations:

a) In the ground-floor lobby of CTV, the subjective picture grading was quite different between these two systems

The received field strengths were almost the same < 44.2 (ATSC) vs. 43.6 dB μ V/m (DVB-T) $>$ and their received spectra looked quite healthy. But the CCIR grading for the ATSC pictures was $< 1 >$ and for the DVB-T pictures, $< 4 >$. With a great deal of RF “clutter” between the transmitting and the receiving antennas, this was a very suitable location for demonstrating the differing characteristics of the two systems under test.

b) Marginal field strength, yet good reception on the 3rd Floor of TTV

As mentioned above, the field strengths at this location were among the weakest encountered during the indoor tests. Nevertheless, both systems achieved a picture grading of $< 4 >$. It is worth noting that there were indeed many other indoor locations where the field strength was greater than E_{\min} , yet the reception picture grades were less than $< 4 >$.

c) Very high field strength, yet bad reception

This happened on the 14th floor of the Tatung company’s building where the window faces North, with an LoS to the transmitter. The field strengths encountered here were of the order of 70 dB μ V/m. However, reception at this location was impossible and it received a CCIR grading of $< 0 >$ for both systems. This is not easily explained. By examining the spectra recorded at this location (see Fig. 15), it can be seen that the low-frequency section was seriously attenuated.

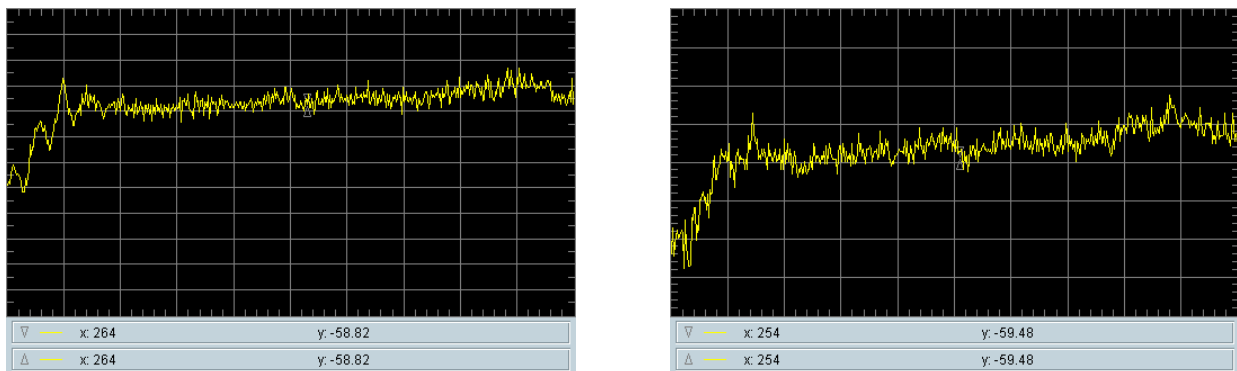

Figure 15
Received spectra of (left) ATSC and (right) DVB-T, showing considerable losses at low frequencies

d) Reception totally using a reflected signal (on the 9th floor of DGT)

The window where reception was evaluated faces south, and there is a large building just in front of it. The transmitted signals were coming from the north, which is heavily shielded by internal office walls. Consequently, reception at this location was totally based on the reflected waves from the facing wall of the nearby building to the south. The results show that the ATSC system was not able to deal with such a situation, but DVB-T produced a CCIR picture grading of $< 4 >$.

e) **Relationship between spectrum flatness and the received vision quality (location 1 – at the south-west corner of the 6th floor of CTS; location 2 – on the southeast side of the 9th floor of DGT)**

Both these locations are not on the LoS to the transmitter and their spectra were seriously damaged by multipath interference (see Fig. 16). The Site Margins associated with location 1 were “not available” for ATSC and were “0 dB” for DVB-T. The ATSC system failed at this location (grade < 0 >) but DVB-T achieved a picture grading of < 4 >. These spectra show how the OFDM technique used in the DVB-T

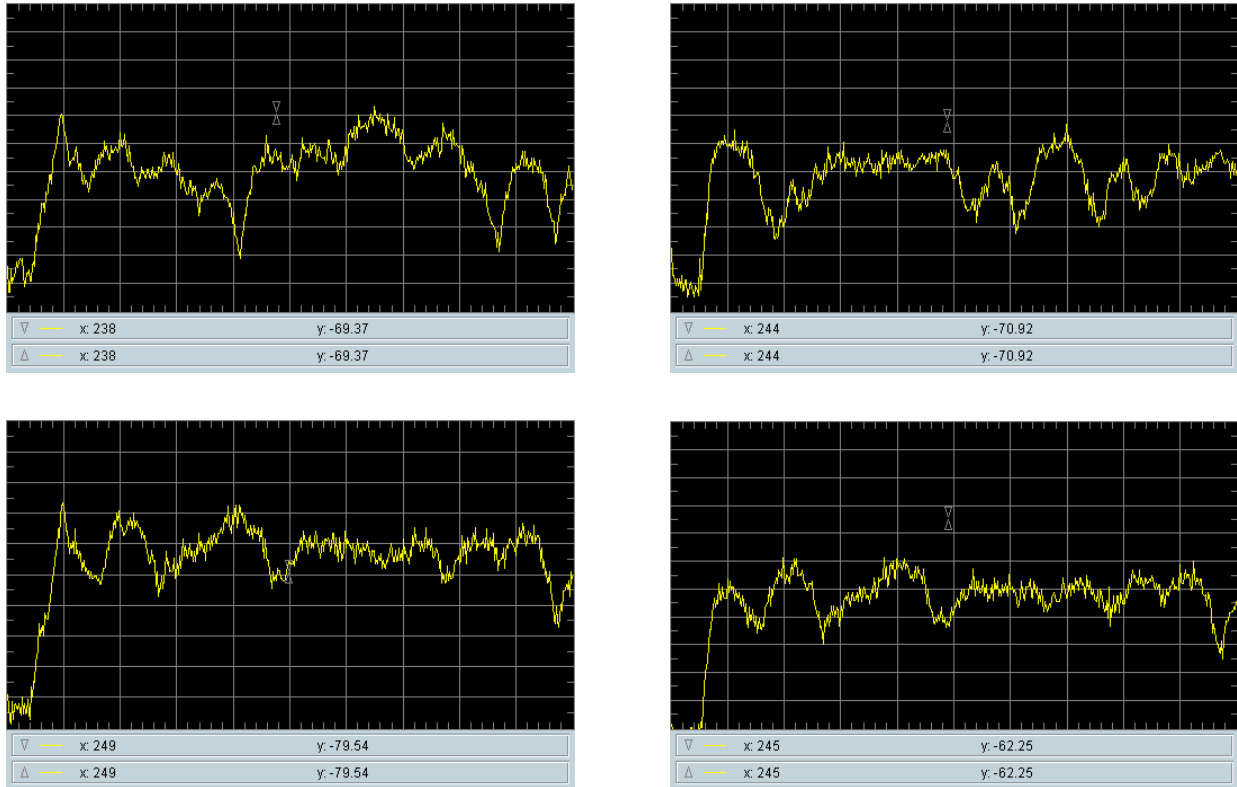

Figure 16
Uneven received spectra:
location 1 – (top left) ATSC; (top right) DVB-T
location 2 – (bottom left) ATSC; (bottom right) DVB-T

Abbreviations

2k	COFDM transmission mode with around 2000 carriers	ETN	East of True North – the direction or bearing, in a clockwise sense, relative to true north
8k	COFDM transmission mode with around 8000 carriers	FFT	Fast Fourier Transform
8-VSB	8-state Vestigial SideBand	GPS	Global Positioning System
16-QAM	16-state Quadrature Amplitude Modulation	HP	Horizontally Polarized
64-QAM	64-state Quadrature Amplitude Modulation	ITU	International Telecommunication Union
ATSC	Advanced Television Systems Committee (USA)	LoS	Line of Sight
BER	Bit-Error Ratio	MER	Modulus Error Ratio
CCIR	(ITU) International Radio Consultative Committee	NTSC	National Television System Committee (USA)
COFDM	Coded Orthogonal Frequency Division Multiplex	OFDM	Orthogonal Frequency Division Multiplex
CW	Carrier Wave	PCMCIA	Personal Computer Memory Card International Association
DTT	Digital Terrestrial Television	QPSK	Quadrature (Quaternary) Phase-Shift Keying
DTV	Digital Television	RF	Radio-Frequency
DVB	Digital Video Broadcasting	S/N	Signal-to-Noise ratio
DVB-T	DVB - Terrestrial	SER	Segment Error Ratio
		SFN	Single-Frequency Network
		ToV	Threshold of Visibility

system can take advantage of multipath signals to reconstruct the picture, even though the received DVB-T spectra were obviously quite uneven. It is worth noting that the received field strengths were quite strong at both locations – around 51 dB μ V/m at location 1 and 57 dB μ V/m at location 2.

f) Role played by the pilot signal

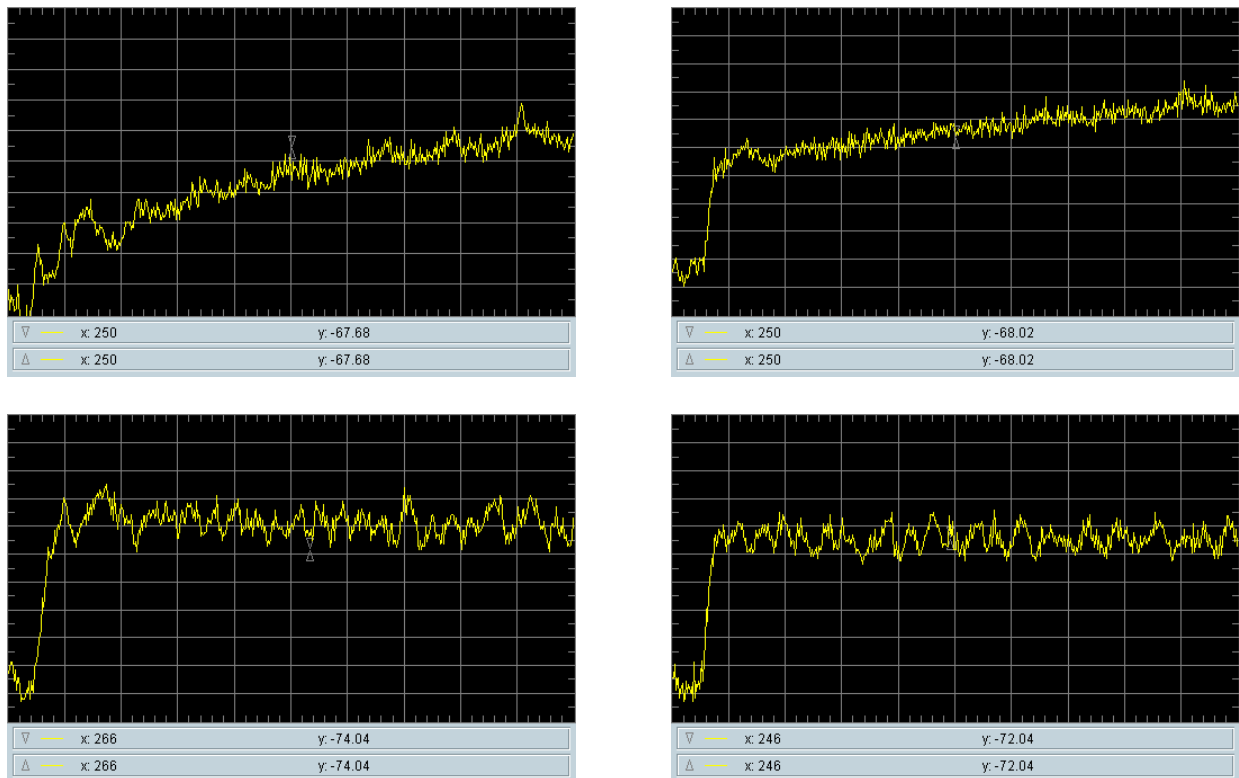

Figure 17
Received spectra in which the ATSC pilot is destroyed:
location 1 – (top left) ATSC; (top right) DVB-T
location 2 – (bottom left) ATSC; (bottom right) DVB-T

At some locations, it was found that the lower end of the received spectra was extremely attenuated; for example, as shown in *Fig. 17*.

The signals in the upper two images (ATSC on the left, DVB-T on the right) were measured on the 16th floor of the Tatung Company building (facing north). It can be seen that the pilot signal of the ATSC spectrum is completely destroyed. The pilot signal – which holds about 7% of the total energy of the channel spectrum – plays a very critical role in the demodulation of the ATSC system [4][9] and is sometimes called simply the “ATSC Pilot” (see *Fig. 18*). Hence, if the pilot signal is considerably degraded, it is not possible to decode the pictures. That is the reason why the ATSC system obtained a picture grading of $\langle 0 \rangle$ at such locations. However, there were no such problems with the DVB-T system (grade $\langle 4 \rangle$ pictures) at these locations.

The two lower images in *Fig. 17* (ATSC on the left) show another similar case where the ATSC Pilot was weakened and the pictures could not be decoded, hence a picture grading of $\langle 0 \rangle$; on the other hand, the DVB-T pictures were readily received (grade $\langle 4 \rangle$). Again, it is worth noting that the electric field strength of these received spectra were all above 60 dB μ V/m, and it is indeed improper to predict the picture quality simply based on the received electric field strength, especially for the ATSC system.

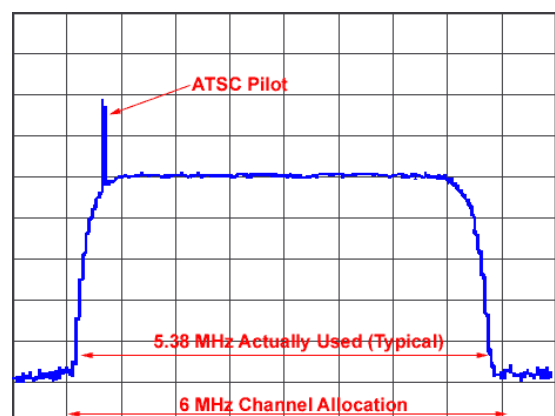

Figure 18
ATSC Pilot



Chi-Fang Huang received his B.Sc. degree in Electronic Engineering from National Taiwan Ocean University (Keelung, Taiwan) in 1981. He obtained an M.Sc. and a Ph.D. in electrical engineering from Tatung University (Taipei, Taiwan) in 1983 and 1990, respectively.

From 1990 to 1997, Dr Huang worked for Chunghwa Picture Tubes, Ltd., Taiwan, on developing new high-precision magnetic deflection yokes for CRTs. From 1997 to 1999, as a Principal Engineer, he worked for Siemens Telecommunication Systems Limited, Taiwan, on designing the high-speed backplane for the SONET Multiplexer. Since 1999, he has been an Associate Professor of Tatung University. His current interests are optical transparent antennas, small antenna designs, high-frequency

techniques and the modelling of high-speed interconnections.

The Nan Chang was born in Tainan, Taiwan, in 1953. He received a B.Sc. degree in Physics from National Taiwan University (Taipei, Taiwan) in 1975, and an M.Sc. and a Ph.D. in electrical engineering from Tatung Institute of Technology (Taipei, Taiwan) in 1980 and 1987, respectively.

From 1980 to 1981, he was a Design Engineer in the Television Department at Tatung Company (Taipei, Taiwan). From 1981 to 1984, he worked in the Antenna Department of the same company, where he was responsible for antenna and RF circuit designs

In 1987, Dr Chang joined the faculty of Tatung Institute of Technology, where he became a Professor in 1990. At present, he is with the Communication Institute of Tatung University, where he is now a Professor and Director of the Microwave Laboratory. He has published around thirty scientific papers. His current research interests are in reflectarray antennas and microwave circuit designs.

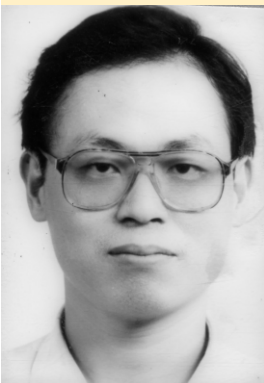

Chau-Yun Hsu received his B.Sc., M.Sc. and Ph.D. degrees in Electrical Engineering from Tatung Institute of Technology (Taipei, Taiwan) in 1981, 1983 and 1988, respectively. He was a lecturer in the Department of Electrical Engineering at Tatung University from 1983 to 1985, and served as the Associate Professor of Tatung University from 1988 to 1997.

Since 1998, Dr Hsu has been the Chair Professor of the Graduate Institute of Communication Engineering at Tatung University. His current interests include wireless-channel modelling and estimation, digital signal processing and image processing.

Conclusions

This article has described the results of comparative evaluations of the **ATSC 8-VSB** and **DVB-T COFDM** digital broadcasting systems. The report which the article is based on was submitted in 2001 to the Taiwanese government authority, for strategic information purposes.

The tests were carried out in the spring of 2001, in three different types of environment; namely, outdoor fixed-point, outdoor mobile and indoor fixed-point. Fixed reception using an external directional antenna was evaluated at 102 locations; mobile reception was evaluated along 12 highways or streets at fast/slow speeds and indoor reception using an omni-directional set-top antenna was evaluated at 103 locations inside seven large buildings. Based on the data gathered, the following conclusions may be drawn about these two different digital TV transmission systems.

- 1) For **outdoor fixed-point reception**, the reliability of DVB-T was found to be statistically better than that of the ATSC system – but not obviously so.

Most Taiwanese people live in city areas where there are many apartments in tall concrete buildings. As a result, the concept of traditional (analogue) TV broadcasting is basically unworkable in many parts of Taiwan and, hence, there is a high penetration of cable TV services. But now, with the arrival of *digital* broad-

casting systems, the European DVB-T system seems best able to cope with this situation – particularly as it can take advantage of the multipath signals caused by building “clutter” in the major towns and cities.

- 2) For **indoor fixed-point reception**, DVB-T showed its superiority over the ATSC system, mainly because of its modulation technology, COFDM.

In this environment, DVB-T is fully capable of dealing with multipath signals. Moreover, the COFDM technique can skilfully use reflected signals to enhance the reception quality – even at locations where no direct signal from the transmitter is present. At locations where the low end of the channel spectrum is degraded seriously, the ATSC system readily fails because of its reliance on the low-frequency pilot signal for demodulation purposes. Technically, the DVB-T system is the more suitable candidate for providing indoor reception in the Taiwanese environment.

- 3) In the case of **mobile reception**, the ATSC system was unable to provide such a service during our tests. When using the optional DVB low data-rate modulation and coding scheme – 2k/16-QAM – the DVB-T system was found to be quite capable of providing a good mobile service. In addition, the COFDM modulation technique has the ability to enhance reception at locations where multipath is present and even severe. This is a strong point and makes DVB-T COFDM a good solution for mobile TV reception.

Acknowledgements

This study was not possible to complete without help from The Television Academy of Arts & Sciences of the Republic of China (the project sponsor). Special acknowledgement must also go to the engineering department of Chinese Television System (CTS) and The Directorate General of Telecommunications, Ministry of Transportation and Communications. Their assistance with this project is deeply appreciated.

Bibliography

- [1] Yiyan Wu: **Performance comparison of ATSC 8-VSB and VSB-T COFDM transmission systems for digital television terrestrial broadcasting**
IEEE Trans. Consumer Electronics, pp. 916 - 924, vol. 45, no. 3, August 1999.
- [2] M. Massel: **Digital Television DVB-T COFDM and ATSC 8-VSB**
digitalTVbooks.com, 1999.
- [3] MapInfo Corporation, USA: <http://www.mapinfo.com/>.
- [4] Linley Gumm: **Signal-to-noise relationships in 8-VSB**
Tektronix Technical Brief, Sept. 1999.
- [5] Tatung University: **Field test on the terrestrial broadcasting transmission standards – ATSC vs. DVB-T**
Final report (in Chinese), granted by *The Television Academy of Arts & Sciences of the Republic of China*.
- [6] Hitop Communications Corp., Taiwan: <http://www.hitopcomm.com/main.html>.
- [7] Chase Communications, <http://www.chase-comms.co.uk/>.
- [8] Maxview limited, UK: <http://www.maxview.ltd.uk/>.
- [9] <http://www.tscm.com/TSCM101HDTV.html>.

Contact

If any readers would like to discuss this article with Dr Huang, he can be contacted at: ras@ttu.edu.tw.

21 July 2003