



The studio

J.J. Bottom (Jeffson Associates, Member AES)

B. Marks (Member AES)

In the embryonic days of sound broadcasting, the microphone and the transmitter were located in the same room. It was not long however before the radio studio developed as a separate entity to the transmitter.

Over the decades, tremendous developments took place in the studio but, as the first century of wireless draws to a close, the trend now - at least with local-area radio stations - is to combine the studio once more with the transmitter site, in a space no larger than most living rooms.

In this brief review, the authors have attempted to cover just some of the key technical developments which have taken place in the radio studio over the years. The topics considered include the microphone, sound mixers, recording and playback devices, stereo programming and studio acoustics.

1. Experimental beginnings

During the latter part of the 19th century, various technical discoveries enabled Morse-code messages to be sent without wires. The invention of the telephone provided the microphone and the earpiece, but wires were still needed to join them

together. The invention of the spark transmitter subsequently allowed speech to be transmitted without wires and the invention of the thermionic triode valve enabled more sophisticated modulation techniques to be developed. Thus, by 1914, the telephone microphone could be connected to a transmitter so that it modulated a continuous radio-frequency carrier.

The intervention of the first world war delayed the use of this transmission technology, except for point-to-point speech communication. It did, however, bring about rapid developments in the technology which were necessary to make broadcasting a viable proposition.

Attempts to have more than one performer required the microphone to be moved further away. In order to make up for the resultant loss of sound level, improvements to the directional characteristics of microphones were introduced.

It was soon apparent that the type of room in which the microphone was located had an effect on the received signal, so acoustics had to be considered. Using the same room as the transmitter caused problems of unwanted noises - not only from the equipment, but from the engineers as well. Hence, a separate room came to be used by the performers.

Inevitably, it became necessary to increase the distance between the performers and the transmitter, and to use more than one microphone in the room so that more complex programmes could be originated. At this point, the fledgling broadcasting industry had separated the programme origination process from the transmission process.

Original language: English
Manuscript received 13/1/95.



2. Early studio designs

2.1. Programme mixing

In these early studios, valve amplifiers were used to raise the level of the microphone signal to that needed for the transmitter. The amplifiers were located with the engineers and the transmitter; any control equipment in the studio was passive. At first, simple changeover switches and, later, switched resistors allowed more subtle transfer between microphones. However, control of the sound level was still with the engineers in the transmitter room. When the transmitter had to be located remotely from the studio, then it was necessary to control the level at the studio, before the signal was sent down the wires to the transmitter. The term *control room* had arrived. Here, the engineers adjusted the gain of the system to maintain a regulated source of audio to send to their colleagues who operated the transmitter.

Ever since the early experiments, gramophone records had been used as a single source of audio. However, by this time, they were being used in “programmes”, so it was desirable to be able to mix them with the microphone signals. For a more complex programme, there was also the need to adjust the relative level of sounds from several microphones. This was achieved by using a mixing panel in a *control cubicle* next to the studio (Fig. 1). Once a system had been developed to

Figure 1
Circuit diagram of an early studio with a separate cubicle and control room.

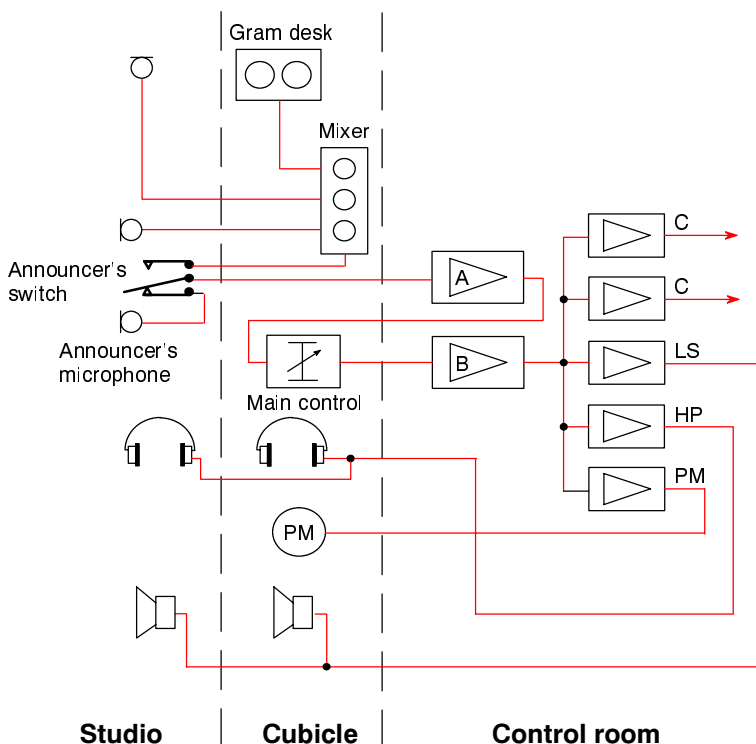

send an indication of studio sound levels back to the cubicle, then the control of both the level and the balance was in one pair of hands – maybe not even those of an engineer! Early methods of monitoring the sound level sent from the studio to the transmitter included the use of valve voltmeters to determine peaks and, later, various types of peak- or volume-measuring instruments.

The amplifiers, and control of the overall sound level, remained in the control room.

2.2. Acoustic damping

The early studios were rooms which had been adapted for broadcasting by reducing the effects of external noises, and by providing heavy acoustic damping. This was usually achieved by hanging curtains and felt on the walls, and by the use of thick carpets. This damping was intended to reduce, for the benefit of listeners, the changes of acoustic sound from performers located at different distances from the microphone; it attempted to provide an anti-echoic chamber. Of course the damping had greater effect at higher frequencies, so the sound was lacking in high frequencies, both for the performers and the radio audience.

2.3. Microphones

The early microphones were *carbon-granule* types, developed from telephone designs. They were inherently noisy, had poor high-frequency performance and required the performer to be close to achieve the required output level. A development by the Western Electric Company gave improved output levels with less noise. It comprised a double carbon-granule button microphone, in which the two elements were separated by a stretched steel diaphragm.

Another type of microphone which was developed was the *photophon* in which a modulated light beam was detected by a selenium cell. This type of microphone did not suffer from the inherent noise of the carbon-granule types.

Soon a new design was introduced – the *condenser* microphone – which made use of the variation of capacitance of the diaphragm and the metal case. However, with this design, a new problem occurred: as the humidity in the studio rose during a performance, dampness developed between the electrodes and caused a noise that became increasingly louder. Operationally, the solution was to keep it in a dry atmosphere prior to use and, if it started to make a noise, to revert to a carbon-granule reserve microphone.



Meanwhile, Capt. H.J. Round of the Marconi Company had developed a *moving-coil* microphone, in which a coil moved in a magnetic field provided by an electromagnet (which took a current of 4 amps from the 8-volt batteries required to power it). The coil was made of aluminium wire and was attached to the diaphragm by means of greased pads, which needed to be replaced before they softened in a hot studio atmosphere.

A variant on the carbon-granule type was also developed by the Marconi Company, based on a system invented by Georg Neumann (who later formed his own microphone manufacturing company) while employed by the Reisz company in Germany. It used a diaphragm - initially made of rubber, then of mica and finally of rice paper - suspended over a cavity filled with carbon granules in an octagonal-shaped piece of marble (*Fig. 2*). However, this design also had its problems: as the granules packed down in the cavity, the output decreased and the noise increased.

All these microphones needed amplifiers of some kind. These were inevitably large, with bulky transformers and capacitors; the electrolytic capacitor was not available yet. Arrangements were made to give some adjustments to the frequency response of the amplifier, by altering the value of bias resistors. The main problems were how to minimise noise and microphony in the amplifier. Direct current from accumulators was used to power them, and valves were carefully selected for best performance and were installed in resilient mounts.

The *ribbon* microphone was developed by RCA in 1931. It used acoustic filters to correct the frequency response and, although it performed well, it required a local amplifier and was expensive. By 1935, the BBC had developed a ribbon microphone which used acoustically-designed pole pieces and a magnet made of cobalt steel; these ribbon microphones had figure-of-eight directional characteristics. The use of an impedance transformer, before the existing amplifiers, removed the need for a local amplifier. EMI produced a moving-coil microphone in 1936, with a very wide polar response, which used a filter in the amplifier to correct its mechanical resonance.

■ 2.4. Recording techniques

Apart from the use of commercial gramophone records as sources of audio, all other broadcasting was live - direct from a microphone somewhere. New technology, which allowed moderate -quality audio signals to travel long distances, enabled the

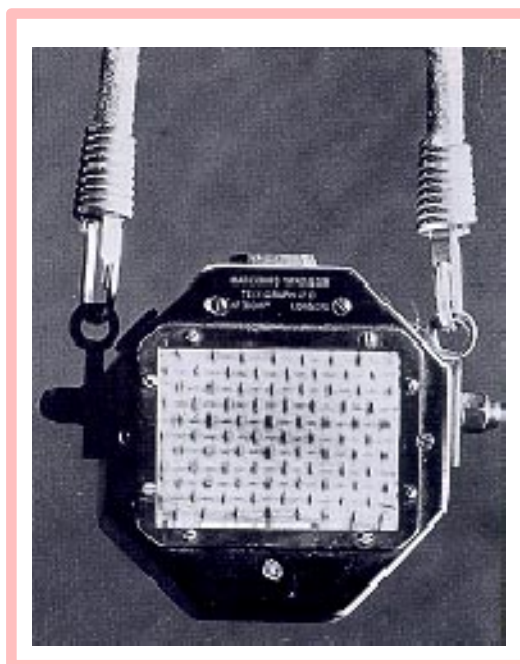

Figure 2
A Marconi-Reisz
transverse-current
carbon microphone
from the late 1920s.

same programme to be broadcast simultaneously from several transmitters.

What the producers needed now was the ability to record a controlled audio signal onto some medium where it could be stored until needed for broadcasting. Such a facility would allow programmes to be produced before the transmission time, and they could be repeated without the performers having to attend again at the studios. In countries where there was more than one time zone, it would enable broadcasters to transmit programmes at a suitable time in all zones. Also, it would allow programmes to be produced at sites that were not yet able to be linked by audio circuits. Lastly, it would be possible to record programmes of historic significance and interest, for use in the future.

■ 2.4.1. Wax recordings

In the early production of gramophone records, recordings were made directly onto wax blanks, which were then used in a complex process to stamp out the finished record for sale to the public. The development of valve audio amplifiers made possible the introduction of electrical recording onto the wax, which provided better quality and greater level control than the previous direct audio recordings.

Wax recordings were also used by broadcasters, in cooperation with record companies, but it was an expensive process if only one copy was needed. Furthermore, the process introduced an unacceptable delay - over 10 hours - before the recording was available to replay. There was thus a need for



a quicker and cheaper method which allowed recorded programmes to be replayed immediately.

■ 2.4.2. Early magnetic recordings

As early as 1900, Valdemar Poulsen had demonstrated his *Telegraphone* at the Paris Universal Exhibition; it recorded telegraphy signals in magnetic form on a steel wire. By 1924, an office dictating machine which used similar principles was invented by Stille and manufactured by the Vox Gramophone Company.

In 1931/2, Louis Blattner - a German who had settled in Great Britain and had formed a company at Elstree, near London - produced a recording machine in cooperation with Stille. The *Blattner-Stille* machine used steel tape which was 6 mm wide, 0.08 mm thick and up to 1600 metres long, and which moved at 1.5 metres per second. It could record for 20 minutes on a reel which weighed 9.5 kg. By late 1932, a version which

used tape 3 mm wide was in use, developed by Von Heising of the English Blattnerphone Company.

In 1933, the English Blattnerphone Company was purchased by the Marconi Company who, by 1935, had developed the *Marconi-Stille* machine (Fig. 3) which had superior performance; a frequency response within ± 2 dB between 100 and 6000 Hz, and a signal-to-noise ratio of 35 dB. The steel tape was made in Sweden and was 3 mm wide, 0.08 mm thick and came in reels containing three 1000 metre lengths welded together. This gave 32 minutes of recording time.

■ 2.4.3. 78 rpm disc recordings

Meanwhile, the gramophone industry was developing improvements. A soft-wax system, with a fast pressing process, was introduced by the British Homophone Company. The Western Electric company experimented with "hill-and-dale" disc cutting, instead of the lateral method used for commercial records. The hill-and-dale system offered more grooves-per-inch but needed a lightweight pickup arm. In 1933, the idea of using a lacquer coating on a solid base was introduced. This allowed a stylus to cut the grooves on the disc, which was strong enough to stand the effects of the replay stylus - the *direct-cut* disc had arrived.

Improvements to the lacquers and the mechanics of the drive mechanisms enabled a reliable system to be developed for broadcast use. Discs of 300 mm diameter offered a playing time of 4.5 minutes; 330 mm discs offered a playing time of 5 minutes.

The only way to edit material was to use two copies of the disc and to switch between them at the required point; jump editing on a single disc was a specialist art form. To record longer programmes, it was necessary to use several discs, an overlap being recorded to allow the playback to appear continuous. To prevent differences in quality when changing between the inside of the first disc and the outside of the second disc (due to the change in relative stylus speed), alternate discs were recorded from the centre to the outside.

■ 2.4.4. Sound-on-film recordings

Another method of making a sound recording was to use photographic film. The cinema industry had by now developed film systems after the initial use of synchronized gramophone discs to give sound to the pictures. The new cinema methods employed either variable density or variable width of a longitudinal stripe on the film to provide the sound modulation; the variable-width method was

Figure 3
A Marconi-Stille tape recorder from the mid-1930s.

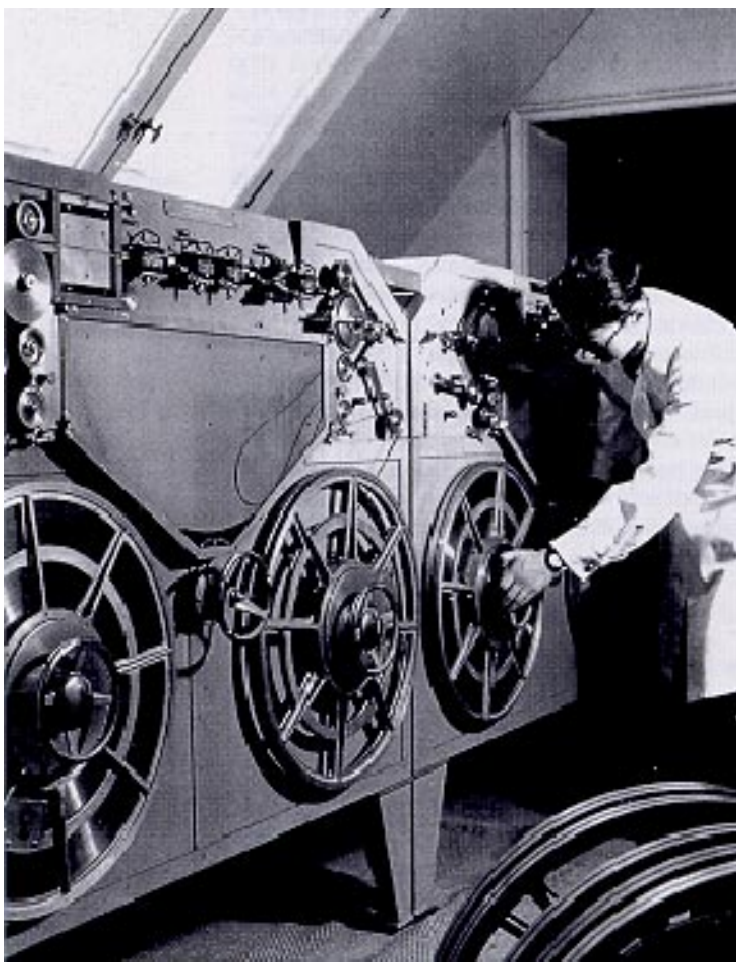

Courtesy of Swedish Radio

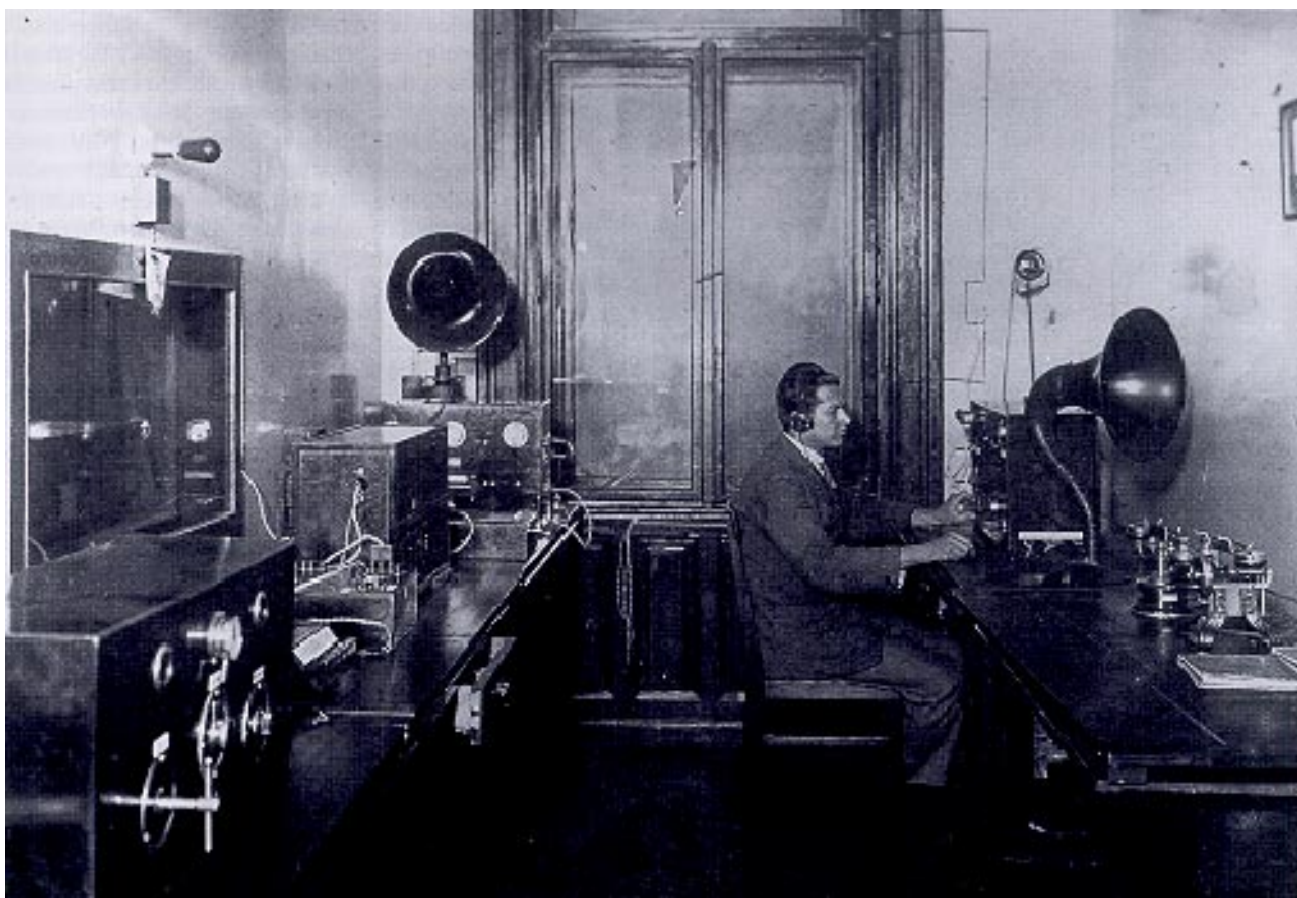

Figure 4
A radio studio in
Budapest, Hungary,
during the 1920s.

used in sound-only machines. Although good quality was achieved, the disadvantages of film recording were the delay before being able to even check the recording, and the greater costs when compared with disc or steel-tape recordings.

A solution, which came from earlier work, used film covered with a coating that was removed physically by the use of variable-width modulation. It did not require any processing. This *Philips-Miller* system, developed in 1932, could record 15 minutes on a reel of film and it could be edited by cutting and splicing. Various changes were subsequently made to reduce the cost of the system:

- the speed was reduced to 200 mm per second from 320 mm;
- the width was reduced to 7.5 mm from 17.5 mm;
- two tracks were cut on separate passes of the film.

In service, it achieved good performance: a frequency response within ± 2.5 dB from 50 to

7000 Hz, ± 6 dB from 30 to 8000 Hz; distortion of 3.5 % at 1000 Hz, 6.5 % at 4000 Hz, and a signal-to-noise ratio of 50 dB. The quality of the film coating was vital to maintaining this performance; the cost per hour was only justified for music recordings.

3. Improved studio designs

While these technical developments were going on, expansion of the industry in the 1930s led to the planning of purpose-built studios and broadcasting centres. New design standards for the different types of studio were developed.

3.1. Acoustics and sound isolation

Firstly, the acoustic requirements of the new studio centres needed to be defined. It was recognised that there was a need to convey a different sound quality to the listener for different programme types, which meant that different acoustic properties were needed for different uses of the studios. Consequently, the reverberation times needed for studios to be used for talks, drama, light



Courtesy of Swedish Radio

Figure 5
Disc cutters as used
in broadcasting
during the mid-1930s.

music and classical music were found by detailed research and experiments.

It was also realised that these new purpose-built studios should be designed with better sound isolation between them and other parts of the building. Studios needed to be ventilated, for the comfort of the artists, but this should not spoil the sound isolation from adjacent rooms, nor introduce any noises of its own. The mechanical engineers and the acoustic architects had to work together to invent methods of attenuating the transfer of sound along ventilation ducts, while maintaining the flow of ventilation air. In the case of complex programmes, it was necessary for there to be visual communication between the studio and its control cubicle. Construction methods therefore had to be developed to achieve this, without degrading either the sound isolation or the acoustic properties of the rooms.

■ 3.2. *Continuity studios*

The way in which the various elements were put together, to produce a continuous transmission of programmes, varied in different countries.

The use of an announcer to link items together was an early technique. In some countries, these announcements originated from the production studio that was on-air. Following such an announcement, an engineer in the central control room would change over the transmitter feed to the next production studio.

In other countries, broadcasters used the same studio continuously. The performers would rehearse elsewhere and then move to the transmission studio when their turn came to be on-air. Some unfortunate errors, and the production needs of wartime broadcasting, forced broadcasters to take more direct control of the programme content.

This led to the adoption of the dedicated *continuity studio*, with a duty announcer in the studio and a balance engineer in the control cubicle. The aim of this technique was to have a focal point for the management of the programme output, for both the production and the engineering functions. Each item to be broadcast could be linked into a continuous programme, any under-running being filled by the announcer. Should an interruption occur for any reason, the announcer was instantly available to speak to the listeners while the engineer resolved the problem. As every transmitted programme passed through the continuity suite, it was important to ensure that the equipment was very reliable; instantly-available standby arrangements were on hand to cope with predictable failures, such as a “blown” valve.

■ 4. *The magnetophon*

During the years of conflict in Europe, developments occurred in most fields of electronics, and broadcasting was no exception. The major development in radio was the progress made in the field of recording. Paper tape, impregnated with iron dust, had been used since 1935 in a German dictating machine. The paper tape was later replaced by a cellulose acetate film, 6.5 mm wide, which was coated with a layer of ferric oxide, 0.01 - 0.02 mm thick. Although the quality was not adequate for broadcasting, the German state broadcaster - Reich Rundfunk Gesellschaft (RRG) - took a great interest in this development.

The breakthrough came in 1940 when Dr Braunmühl and Dr Walter Weber of the RRG used the idea of *HF bias* during recording, to move the wanted signal into the linear part of the transfer curve (until then, direct-current bias had been used in both wire and tape recorders). When a 100 kHz bias signal was used at a level larger than the audio signal, the remnant magnetism - after several



cycles of the HF bias - was found to be proportional to the audio signal over a wide range of amplitudes. The use of HF bias extended the frequency range, reduced the non-linear distortion and removed most of the background noise which was inherent in earlier tape systems. The RRG went on to develop a range of machines called *magnetophons* which used HF bias.

In the course of the war, new magnetic tapes were produced which used polyvinyl chloride and magnetite in a homogeneous combination. This formulation was succeeded by a polyvinyl chloride tape, coated in a magnetic layer. In contrast to the steel tapes used in the Blattnerphone and Marconi-Stille systems, the magnetophon tapes were thin, light, easily cut and rejoined, and cheap to make.

After the war, the magnetophon was widely demonstrated outside Germany. It was claimed that one version (type K7) had a frequency response within ± 2 dB from 50 to 50 000 Hz, a signal-to-noise ratio of 50 dB and a total harmonic distortion of 3 % at 1 kHz. The magnetophon was seen to offer great potential and several countries went on to develop their own versions of what came to be known simply as *tape recorders*.

5. Portable tape recorders

Following the introduction of magnetic-tape recording systems in radio studios, it was not long before operational staff wanted a similar capability for outside broadcast use. The first portable tape recorders - for example the EMI Midget recorder, weighing only about 8 kg - were introduced in the early 1950s. They immediately saw service all around the world, despite the fact that the small tape spools permitted only very short recording times, at 38 cm/s.

Of course these early tape recorders were looked after by engineers who could keep them well adjusted. In particular, the mechanical demands were great to achieve correct azimuth of the tape-to-head contact. Also, the tape formulations were still rather variable and the bias often needed adjustment to obtain the generally-quoted total harmonic distortion performance of less than 1% at full output. To satisfy the desire of news reporters to record actuality at the scene of an event, it was necessary to wait until the early 1960s when economically-priced portable tape recorders were introduced. The best-known example is probably the German-manufactured Uher 4000, which was used in large numbers by many broadcasters.

It was also around this time that the Swiss-made Nagra portable recorder was introduced; it offered exceptional performance for its day. Interestingly, the Nagra was used widely by broadcasters but in somewhat differing roles: it was used by OB engineers where high-quality recordings were needed, as it allowed adjustments to be made (to the bias for example) to optimise the performance; it was also widely used by field reporters who just wanted a machine that would record at the press of a button, although the alignment would have been done beforehand.

6. Microphone improvements

Moving-coil and ribbon microphones continued to be the mainstay of broadcasting throughout the post-war period. The BBC-Marconi ribbon microphone, for example, went through several modifications from type A to AX, to AXB and finally became the well-known AXBT. It gave excellent results but was rather bulky. Mounted on a very heavy desk-top base, and with a height of about 420 mm, the AXBT microphone certainly intruded upon any across-the-table conversations in the studio.

A BBC-designed ribbon microphone was introduced in 1953. About one-third of the size of the AXBT, it was manufactured as the STC 4038 and became known as the PGS. It quickly became the most common studio microphone at the BBC, right through to the 1980s.

Although capacitor microphones (then known as condenser microphones) had been used experimentally in the 1930s, their performance was

Figure 6
A portable tape recorder of the 1950s, the AEG Magnetophon K4.

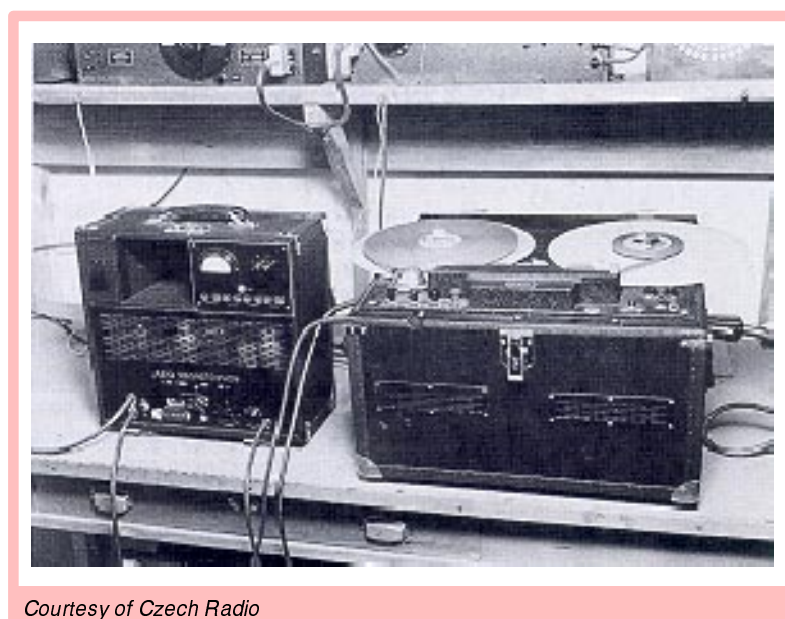

Courtesy of Czech Radio

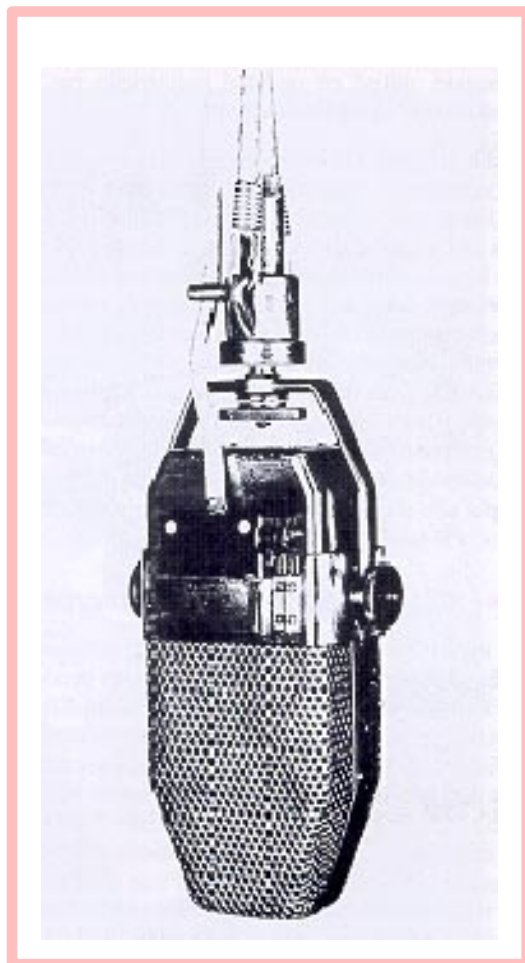

Figure 7
A BBC-Marconi
Type AXBT ribbon
microphone from
1935.

unsatisfactory. The AKG C12, developed in the early 1950s, was introduced for drama productions where the possibility of a variable response pattern was attractive. Further developments to microphones continued but, as most designs already had excellent frequency responses (virtually flat from about 20 Hz to 16 kHz), there was little impetus to better their performance, except in terms of signal-to-noise ratio.

7. The start of VHF/FM broadcasting

The 33 $\frac{1}{3}$ rpm long-playing (LP) record appeared on the domestic market in 1950. Its technical performance showed the listener what could be achieved in a purpose-built recording studio and what was required in the home to reproduce audio with a very acceptable performance. Clearly, broadcasting would have to catch up.

In Europe, the lack of adequate LF and MF frequency assignments, and the notorious “after dark” reception effects, motivated the move to VHF/FM sound broadcasting. Mono FM services

began in Europe in the mid-1950s and this greatly improved the quality of the received signal, particularly in terms of bandwidth and signal-to-noise ratio.

Programme-makers now had the opportunity to improve the technical quality of their productions, but there would be a need for new buildings to house the improved studios and operational areas. Thus, from the mid-1950s onwards, European broadcasters invested considerable funds in the construction of new sound broadcasting centres.

7.1. Further acoustic improvements

These new broadcasting centres were designed, with few exceptions, to house the first purpose-built studios which took proper account of sound isolation, and which produced reverberation times that permitted good artistic performances as well as good broadcast signals. The “box within a box” construction technique was frequently used to provide adequate sound isolation to the outside, and between studios within a building.

Ultimately, high-mass walls are the key to good isolation. Thus, many of these new studio centres were built in reinforced-concrete, with relatively thick walls of up to 0.5 m in places. However, large concrete boxes need extensive acoustic treatment, and careful illumination, to permit artists to work in an acceptable environment. Hence, modular absorbers - with differing characteristics, but of the same size - were developed by several organizations. They were an excellent way to provide the correct acoustic treatment for the wall and ceiling surfaces, and they permitted relatively-easy fine tuning of the acoustics during the construction phase.

7.2. Custom-designed studio equipment

The building of new studio centres in the 1950s provided the opportunity to install custom-designed equipment. Eventually, this equipment became self-contained in the studio control room; connections to the various inputs and the output were made in a separate master control room.

At this time, equipment reliability was still an important issue. Some designs used plug-in amplifiers and faders, in the belief that they would be quick to replace if a fault developed during a production. With so many contacts that could become “dirty”, faults did occur rather too often and this generation of studio equipment had to be replaced after a relatively short time.



Courtesy of Radio France

Figure 8
A studio desk of the 1950s, with linear-track faders. The bass speaker units were formed within concrete tubes to eliminate the resonances which are common in wooden enclosures.

By the early 1960s, many broadcasters were in a position to specify much more complex studio mixers which required not only substantial numbers of microphone channels, but also numerous inputs for external sources.

This led to the need for a large control room to route such connections to the appropriate studio, just for the duration of a particular broadcast. The last studio desks to use thermionic valve amplifiers were installed in large numbers during this period. These designs used standardised plug-in amplifiers, mounted more satisfactorily than in previous versions. Permanently-wired faders were used in areas where low-level signals were present, which resulted in much-improved reliability. The design allowed for channel mixing of the microphones used for music and drama applications, or for news applications where the emphasis was much more on outside sources and the need to provide clean feeds to the distant contributors.

8. The start of stereo broadcasting

When stereo transmissions became possible in the early 1960s, radio programme origination

required a completely new set of techniques and equipment - right through the broadcast chain from the microphones to the transmitters. The necessary developments were quite gradual, in view of the high costs involved.

The original stereo productions were mostly music OBs, where it was felt that the maximum advantage would be given to the listener. These OBs used transportable valve mixing desks, with mechanically-ganged quadrant faders, which provided just three stereo mic/line channels, one stereo echo channel and a number of pan-potted mono channels.

However, with the effective doubling of amplifiers and other electronic elements in the broadcast chain, it was hugely advantageous to use transistorised designs with their reduced power and size requirements. With few exceptions, the earliest transistorised mixers were noisy by today's standards, and still tended to be designed by broadcasters. Whilst they offered many new facilities, such as response selection amplifiers which greatly helped news productions, they were quickly deemed inadequate for stereo music and drama productions.



Figure 9
A commercially-designed studio control room from the mid-1970s, with multi-track recording facilities.

■ 8.1. *Commercially-designed equipment*

The domestic market for LP records and, in 1963, the introduction of the compact cassette had greatly expanded the need for high-quality stereo production of pre-recorded music. Many record companies around the world were building very high-quality studios, and installing extremely advanced stereo mixers and stereo tape recorders. Their commercial outlook, and successful selling techniques, allowed them to consider a much more frequent replacement of equipment than broadcasters, and this led to a wider choice of suppliers now offering equipment to the broadcasters.

■ 8.2. *Multi-track recording*

The use of multi-track recording was only a short step away. Firstly, 8-track tape recorders which used 25.4-mm tape were introduced in the mid-1970s. The pace of developments in tape formulation and recorder technology was very rapid and, by the mid-1980s, 24-track machines which used 50.8-mm tape had become common in broadcast sound studios.

Whereas the track-width on a 1950s tape recorder was around 6 mm, it had narrowed to under 2 mm

on this new generation of 24-track machines. In retrospect, it is interesting to note that multi-track recording only became a possibility as a result of the development of noise-reduction techniques, such as Dolby A.

■ 9. *Telephones in programmes*

Broadcasters have used *telephones* since the earliest days to communicate between studios and other parts of the programme origination chain, but the technical and regulatory climate had only allowed one-way reports to be used as programme sources. Usually, these reports were pre-recorded to allow time for editing before transmission.

As a source for live broadcasting, the telephone requires a 2-wire-to-4-wire interface so that the mixer can separate the send and receive signals. Essentially this is the function of the so-called *Telephone Balance Unit* (TBU) which was developed in the early 1970s. As the far-end telephone instrument usually has a relatively poor performance, it is the job of the TBU to achieve as much separation as possible and this can be realised with appropriate electronics, including filters. Once this development was available, it quickly became a common matter to use listeners as part of the



programme - in so-called *phone-in programmes* which are still used widely today.

10. Domestic equipment for broadcasting

From the 1970s onwards, studio techniques made increasing use of equipment derived from the domestic audio market. Various improvements in the performance of domestic record players, tape recorders, cassette recorders, hi-fi amplifiers, loudspeakers and CD players found favour with broadcasters who were continually looking for cheaper and smaller audio equipment.

Pre-recorded material was becoming the mainstay of many radio stations and, often, the wow-and-flutter performance of gramophone players would be considered below broadcast quality. Similarly, tape machines - and even more so, NAB tape cartridge machines - also suffered from the need to maintain their mechanical alignment continuously. Huge amounts of engineering effort were employed to keep these reproducers up to acceptable standards of quality. Given this high level of maintenance effort, it is somewhat surprising that a domestic record turntable - with superb mechanical performance and needing little or no adjustment - became available from the Technics company and was quickly developed and incorporated into many professional disc reproducers.

As soon as Compact Discs were introduced into the domestic market, it was important to provide suitable CD players for broadcasting purposes. The Philips company recognised the need for a professional player which they offered at the launch of CDs. These players used essentially the same signal processing chain as the domestic product, but allowed track access and cueing - so vital to the smooth presentation of a CD-based radio programme. Other manufacturers soon followed and it was now commonplace for broadcasters to work with a commercial company to develop equipment suitable for broadcast programme origination. Perhaps one of the most remarkable examples follows.

News and field reporters always wish that the equipment they have to carry is as small and light-weight as possible, to ease their travel arrangements. Some intrepid field reporters started to use domestic cassette recorders in this role as a substitute for the rather heavy portable open-reel machines of the day. However, they soon found that the signal-to-noise performance of the cassette recorder was very poor and the wow-and-flutter was not much better. Nevertheless, the facility to make unobtrusive recordings on light-weight equipment could be balanced against the follow-up studio time needed to enhance the recordings for transmission. Clearly this message was understood by the Sony company who introduced the Pro-Walkman cassette recorder in the early 1980s. About one-sixth of the size of its predecessor (the Uher 4000 portable open-reel recorder) and much

Jeff Bottom began his career at the BBC as a sound technical operator at Broadcasting House, London, in 1964. After working in the central control room and the network continuity studios, his operational and installation experiences were broadened by the introduction of BBC Radio One in 1968.

In 1974, Mr Bottom joined the installation department, which involved working throughout the UK. He became responsible, in 1984, for the re-equipment of the London central control room and, subsequently, became Project Manager of the total building refurbishment and extension of Broadcasting House, London.

Jeff Bottom now works as a freelance project manager and broadcast engineer, in the field of studio and network engineering. He is a Member of the Audio Engineering Society.



Bev Marks joined the BBC directly from school. He trained as a broadcast communications engineer at the BBC Engineering Training School and qualified in 1968. He held appointments in both BBC Radio and Television during a span of over 25 years; his projects included the experimental broadcasting of Parliament, and digital audio transmission. He was the BBC's Project Manager, RDS, during its formative years.

Mr Marks was a member of several EBU groups concerned with RDS, and has published many articles on the subject over the last 10 years.

Bev Marks now works as a freelance broadcast engineer, specialising in broadcast data systems and advising on training, installation and standardization. He is co-editor of the EBU/RDS Forum Newsletter and is a Member of the Audio Engineering Society.



lighter, this stereo recorder was technically very good and became an immediate success. Whilst not the first equipment to use integrated circuits in broadcasting, the inclusion of Dolby B noise reduction on a single chip made its high performance possible.

11. Programme origination returns home

Very low-cost broadcasting has now become a reality due to the availability of commercial studio equipment which uses audio ICs with acceptable signal-to-noise performance, and the development of low-power solid-state transmitters. These advances, combined with a lighter regulatory touch, have enabled many smaller radio stations to take to the air. Up to the mid-1980s, these stations tended to follow established patterns of using a studio which was quite separate from the transmitter site. More recently, radio broadcasting has almost turned full circle, with all the technology contained in a single room! Today, excellent quality performance can be obtained from a small local-area radio station, powered by a normal domestic electricity supply.

Meanwhile, the development of Integrated Services Digital Network (ISDN) technology has allowed full-quality interconnection between programme sources and main broadcast studios. Whilst this technology originally found a use at OBs, it is now regularly used by radio presenters who, using a close-mic technique and a small mixer, can present a radio programme - interspersed with CD music - live from the living room of their house!

It would be interesting to have an insight into programme origination in years to come. The proponents of DAB are already thinking about using the data capacity to provide not only a high-quality audio service, but also to download pictures. In the years ahead, will the difference between television and radio studios really be so obvious?

Bibliography

- [1] Pawley, E.: **BBC Engineering: 1922-1972**
BBC Publications, 1972.
- [2] **BBC Recording Training Manual**
BBC Engineering Training Department, 1950.
- [3] **BBC Engineering Training Manual**
BBC Engineering Training Department, 1942.



Guglielmo Marconi broadcasting from the London station 2LO in 1930.



The music studio of Radio Cadiz, Spain, in 1925.



A Radio OB vehicle in Portugal (1937).

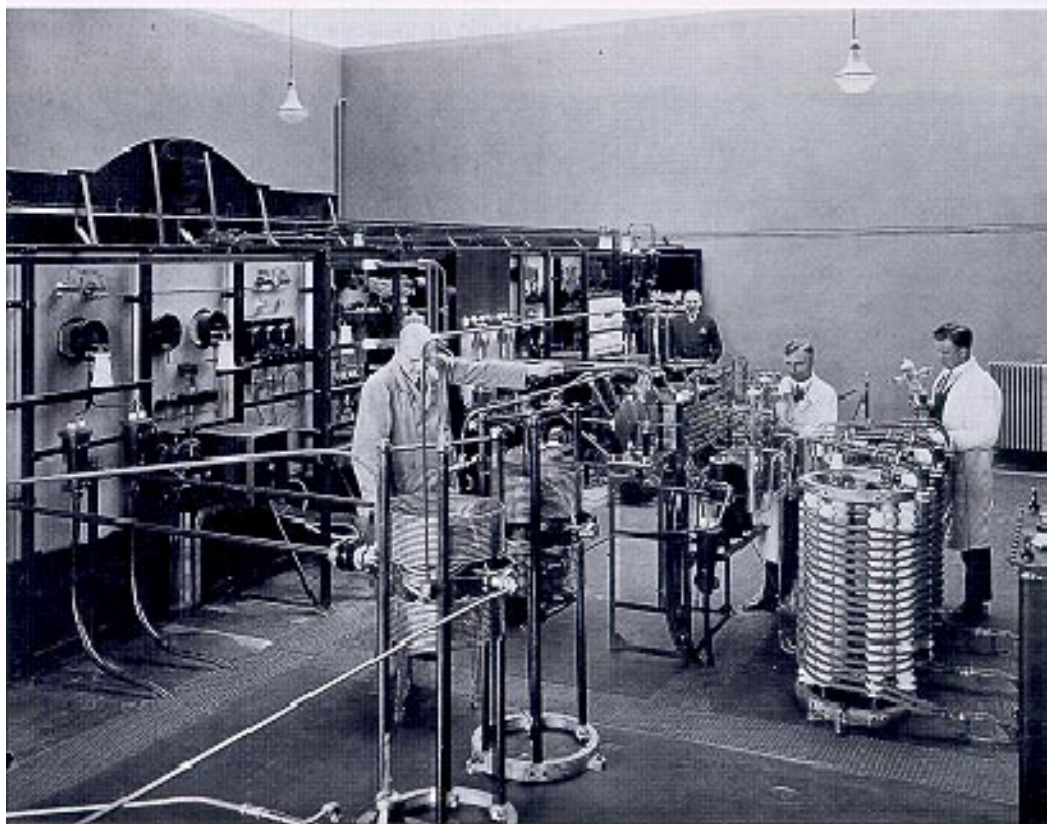

Front view (top) and rear view of the Langenberg HF transmitting station near Dortmund, Germany, during the late 1930s.