

— A fresh look at **single** and **diversity** receivers for mobile and portable reception

Yannick Lévy

DiBcom

With the emerging threat from broadband television (xDSL-TV), broadcasters must use DVB-T for what it is really good at – *portability* and *mobility*. This article shows how diversity reception can significantly improve DVB-T reception on the move and on portable TV receivers.

When DVB-T was developed in the late 1990s, it was intended to provide the best solution for the switchover from analogue to digital television – without any additional requirements. As time went by, the digitalization of television was implemented over satellite and cable, thus making the launch of Digital Terrestrial Television (DTT) a rather difficult story – especially for the broadcasters, who still view it as a new competitor to satellite and cable – with high transmission costs but without the benefits. While DTT was initially viewed as the simplest technique to replace analogue TV (by using pre-existing receiving antennas), it happened that DVB-T deployment was not so straightforward, thus making it a hurdle for the consumers to install, just as it is for satellite or cable today. With new DSL-TV services coming up and further simplifying the installation for the consumers, DVB-T must be viewed for what wireless is really good at: **portability** and **mobility**.

Technically speaking, however, DTT is not so simple to receive in the portable or mobile modes. Besides the network densification aspects – which cause problems due to the continuation of analogue TV for some more years, and the costs relating to such densification – the DVB-T standard (ETSI EN 300 744) has very different constraints when used in fixed reception mode than in portable/mobile mode. In fixed mode, the DVB-T standard indicates minimum values of Carrier to Noise-and-Interference $[C/(N+I)]$ ¹ that are required for an additive white Gaussian noise channel. This can easily be expressed as a function of the signal strength required in the reception area, so it looks as if it is “just a problem for the broadcaster”. However, although the standard also gives a minimum C/N value for Rayleigh and Rice channels, experience in the field shows that (i) these C/N values do not consider all statistical realizations of existing Rayleigh and Rice channels and (ii) the required C/N values do not exist everywhere in the field. It is thus necessary to find solutions at the receiver – e.g. **diversity** reception – to compensate for this. Thus, for a standard (non-diversity) DVB-T receiver, situated in a sufficient field-strength area, only **a certain percentage of the area can properly receive DVB-T signals**.

The results given here were derived from several measurements made during the European *Confluent* project and from measurements made by DiBcom during the testing of its DVB-T integrated circuit (IC).

Description of the DVB-T demodulator chip

The DVB-T demodulator chip used for the tests was the DiBcom *DIB3000-M* 2k/8k COFDM demodulator IC which uses the most recent state of the art in signal processing to offer high performance for mobile, portable

1. For simplicity, $C/(N+I)$ is replaced in this article by C/N .



Figure 1
DIB3000-M demodulator chip

and fixed reception of DTT signals compliant with the DVB-T standard (EN 300 744).

The *DIB3000-M* performs all the processing from sampling the analogue IF input signal to MPEG-2 output. It offers very robust algorithms that allow the demodulator to synchronize and extract the TS parameters, even with $C/N = 0$ dB (*used for antenna positioning*).

Dual-control AGC (IF/RF) was implemented in order to offer very high dynamic range control. In addition, the gain slopes of the IF and RF amplifiers are digitally compensated to ensure a linear behaviour in the AGC loop (*used for portability and mobility*).

A digital filter with high rejection capability is added to cope with adjacent channels. Combined with the interpolation function, it allows the circuit to demodulate 8, 7 or 6 MHz channels without changing the analogue front end (same tuner, crystal and 8 MHz SAW filter).

Specific functionalities are implemented to give optimized performance in *portable* and *mobile* environments:

- Dynamic FFT window positioning gives the circuit the ability to track any change in the channel profile (with post- or pre-echoes) on a symbol-per-symbol basis.
- Accurate channel estimation for high Doppler frequency (up to 120 Hz for 8k modes; 220 km/h at 600 MHz).
- FFT leakage suppression capability makes the *DIB3000-M* chip able to compensate for inter-carrier interference (ICI) due to the mobile environment.
- Diversity combining is provided by the *DIB3000-M*. It is very simple to connect the different circuits together.

Configuration and monitoring of the circuit is done using a serial bus. The high monitoring capability provides: channel profile, MER, C/N after demodulation, BER and PER (Packet Error Rate).

Designed using advanced 0.18 μm technology, the *DIB3000-M* operates at commercial temperatures.

Diversity reception

The Diversity2 receiver used is an evaluation board which was designed to show the performance of the *DIB3000-M* demodulator chip and to give an example of its implementation.

The combination of the two signal paths is based on the *Maximum Ratio Combining* (MRC) algorithm, which offers the best way to combine signals received from different antennas without hardware switching which may cause some signal loss in the system.

This board (*Fig. 2*) can be configured either in single reception mode or in diversity mode (dual mode).

The RF signals at the input to the board are processed as follows:

- Each tuner amplifies the selected RF signal. The demodulator chip controls the amplification gain.
- Each tuner down-converts the amplified RF signal to an IF of 36.125 MHz.
- Each IF signal goes through a SAW filter that rejects the adjacent channels.

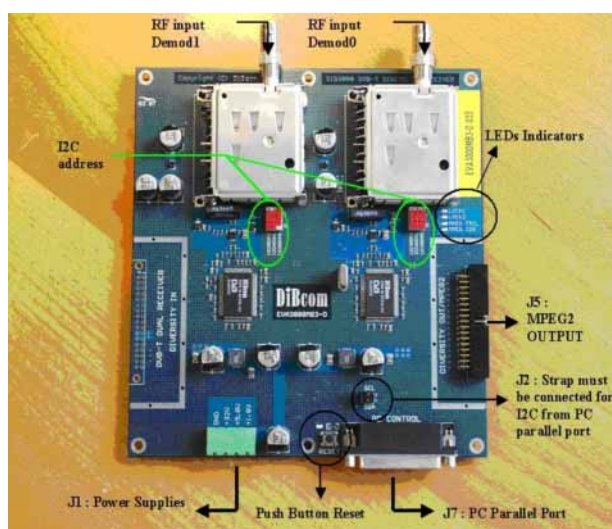

Figure 2
Diversity2 DVB-T receiver

- At the output of each SAW filter, the signal is amplified again using an IF amplifier having a variable gain controlled by the associated *DIB3000-M* chip.
- Each IF signal is then sampled by one *DIB3000-M* chip and the signal is digitally processed to demodulate the signal.
- The first *DIB3000-M* sends its demodulated signal through the diversity interface to the second circuit. This second circuit combines the incoming data with its internal demodulated signal in order to provide the “MRC-combined” signal. This signal is then decoded in the FEC block (Viterbi, R-S) in order to provide the MPEG-2 transport stream.
- The output signal is delivered in MPEG-2 TS format with TTL level, but the diversity receiver can be provided with two optional boards:
 - **LVDS parallel interface board**: can be used to interface the board with an MPEG-2 decoder.
 - **USB board**: can be used to watch TV content on the PC while monitoring the performance of the circuit.
- Windows™ software is provided with this kit and allows control and monitoring of the board using a parallel port.

It should be noted that not only the last chip is able to give performance information (BER, PER, C/N , etc.) but the intermediate one can also deliver such information. Practically, this means that simultaneously the first chip provides performance information concerning **single** reception while the second chip gives performance figures on **diversity** reception. This functionality is extremely useful for mobile or portable tests as it avoids the need for two measurements to be made at an identical place and at the same time!

Mobile reception in diversity mode

Description of the mobile test equipment and quality criteria

Mobile field tests were performed in several European and Asian cities during 2002 and 2003. The results obtained are analyzed hereafter.

The test equipment installed in a vehicle (*see Fig. 3*) consisted of:

- one DVB-T diversity board connected to a small USB interface board and integrated in a box powered from the vehicle’s 12V DC;
- one laptop PC receiving, via USB, the MPEG-2 TS (PID filtered) coming from the diversity receiver;

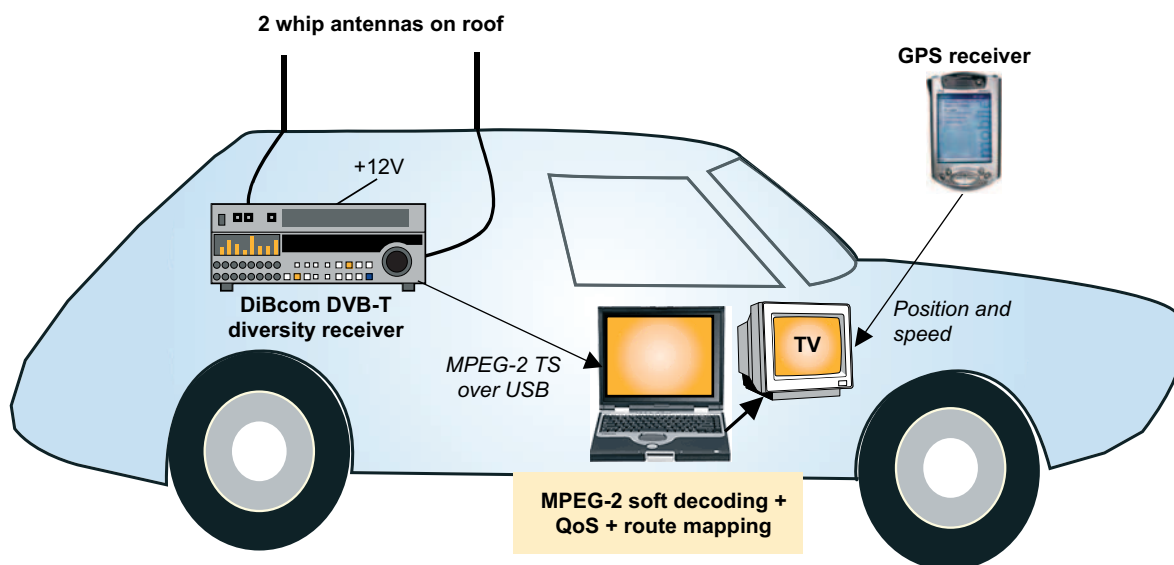

Figure 3
Vehicle test equipment used for mobile DVB-T measurements

- two magnetic antennas;
- one GPS receiver.

The laptop PC recovers the video via MPEG-2 decoding software and plots coverage maps using position and speed information coming from the GPS, and QoS information extracted from the DVB-T signal.

Thanks to the Cascaded Diversity principle, it was possible to measure the mobile performance in the single and diversity modes simultaneously.

In the following sections, the maps use the colour-coding scheme shown on the right to depict the quality of single and diversity reception along the test routes chosen in each country.

- PER = 0 (no packet errors) during the last 3 seconds
Perfect video
- PER < 10% during the last 3 seconds
Acceptable quality: very short picture freezes
- PER > 10% during the last 3 seconds
Poor video reception: blocking, or frequent picture freezes

Coverage in single and diversity modes in Germany

Fig. 4 (upper) shows the quality of reception at 506 MHz for the single DVB-T receiver while driving from Berlin to Brandenburg via Potsdam. This area is covered by two SFN DVB-T transmitters – one in AlexanderPlatz (Berlin city centre) and the other in Schaferberg. The DVB-T mode used in Germany is 16-QAM, rate 2/3.

For the same route it can be seen in Fig. 4 (lower) that the diversity receiver significantly improves the quality of reception:

For a QoS better than 90%, the maximum speed allowed with a single receiver is around 130 km/h. This speed limit rises to 150 km/h with a Diversity2 DVB-T receiver. For QoS > 80%, the speed limit is 130 km/h in single mode and 165 km/h in diversity mode.

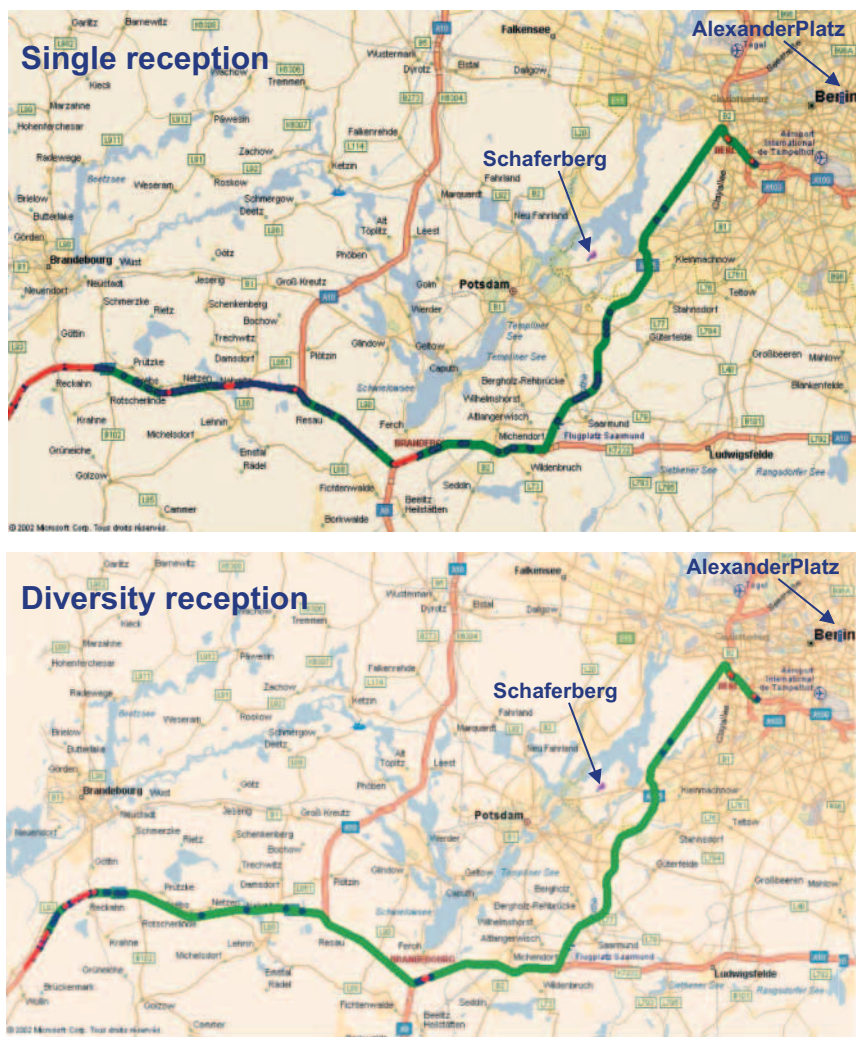

Figure 4 Single and diversity reception in Germany at 506 MHz: 16-QAM

Coverage in single and diversity modes in France

For a given QoS, the speed and coverage differences between the single and diversity modes are even more dramatic when using 64-QAM rather than 16-QAM, as shown in Fig. 5.

Coverage in single and diversity modes in the UK

Although the UK has switched some of its multiplexes to 16-QAM 3/4, the 2K mode makes it a very specific situation in Europe. Fig. 6 shows the single vs. diversity results over a route near Cardiff in South Wales.

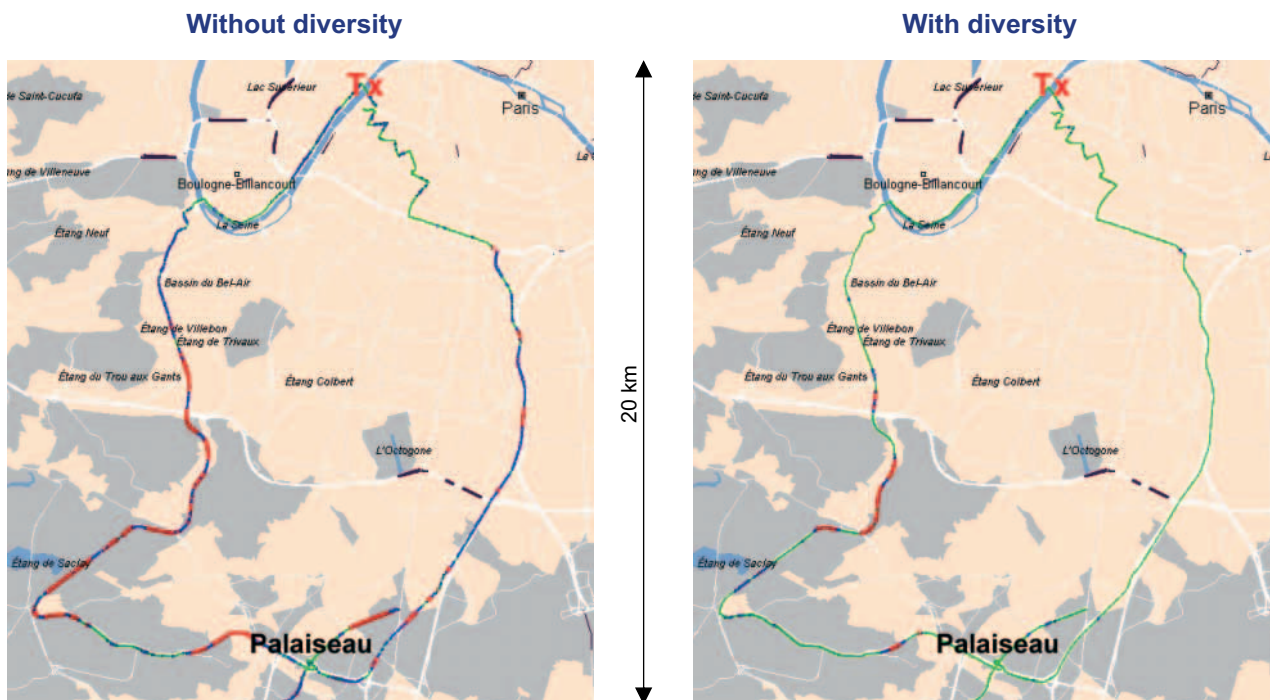

Figure 5
Comparison between single and diversity modes in France: 64-QAM

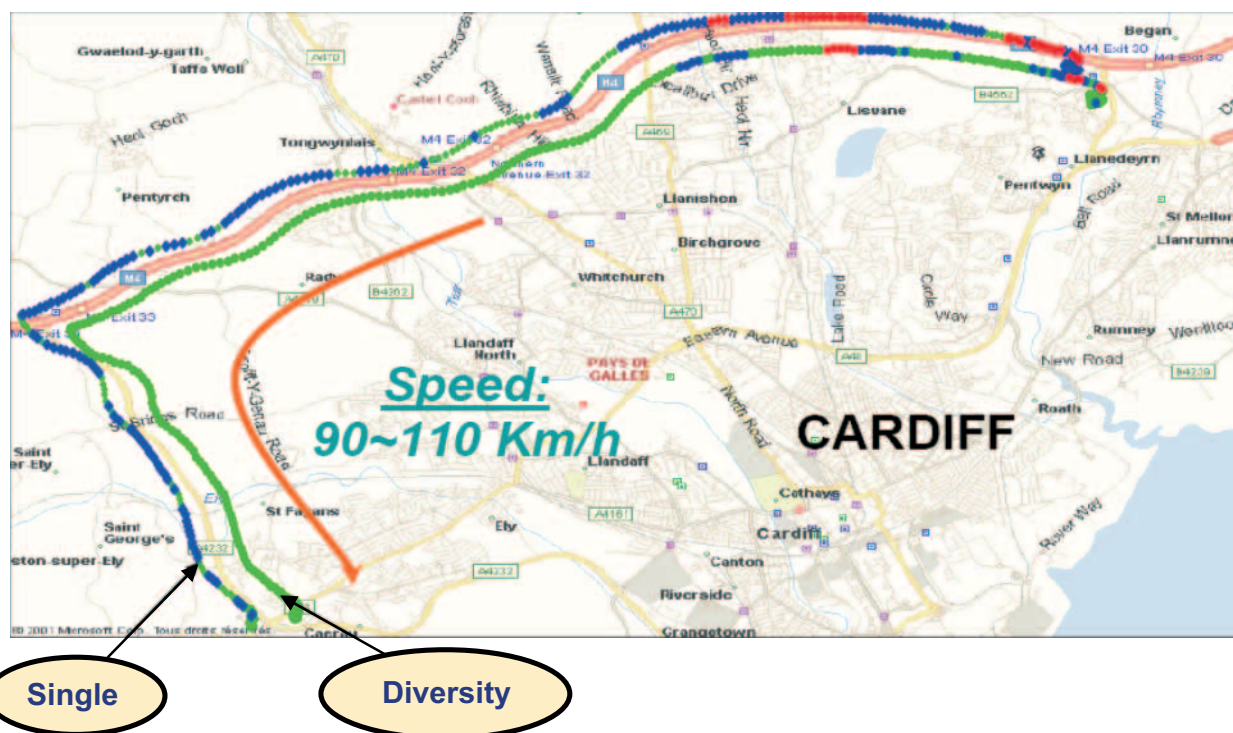

Figure 6
Comparison between single and diversity modes in the UK: 16-QAM, 2K

Portable reception in diversity mode

Portable reception has different requirements than mobile reception. From the user's point of view, the objective is to be able to position the reception antenna as close to the TV as possible in order to avoid any cables running across the room. Therefore, the important criterion is the percentage of a room that is covered by a single-mode receiver versus that of a diversity receiver. For this purpose, the measurements made during these tests used two antennas situated in a 50 x 50 cm square, at a height of between 0.7 and 1m above the floor.

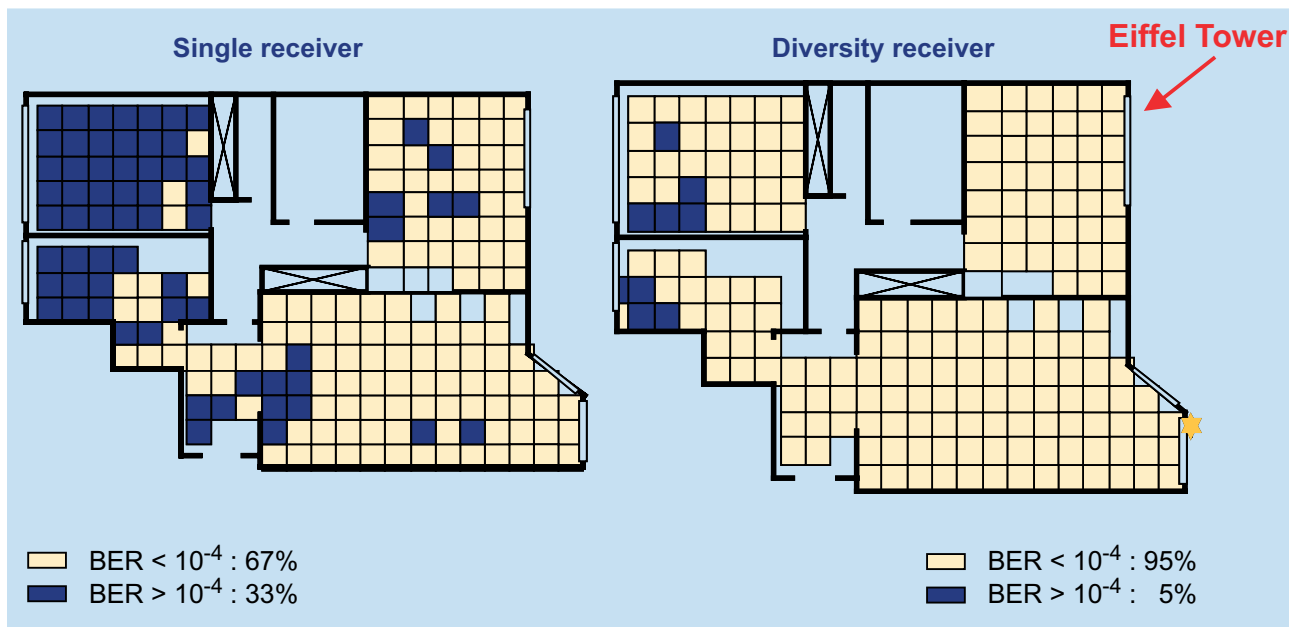

Figure 7
Comparison between single- and diversity-mode reception indoors in France (64-QAM, 2/3, 8K)

With reference to *Fig. 7*, the yellow-coloured squares indicate the indoor areas where an antenna position could be found, giving error-free reception for a few seconds on one multiplex. The blue-coloured squares indicate where no antenna position could be found to achieve satisfactory reception. These measurements were made in France, that is with 64-QAM rate 2/3.

Also, one question that comes back quite often is how the polarity of the antenna and the presence of an active antenna also influence the reception quality. Although indoor measurements are extremely difficult to implement as it takes a very long time to acquire all the data for every square meter of the room, it is interesting to see the improvements gained indoors by the use of a diversity receiver. Intermediate colours have been used in *Fig. 8* to indicate the potential margin that can be lost if anything happens (time variations, people moving about the room, multiplex zapping, etc.). In *Fig. 8*, not all squares in the room have been measured, but only a rectangle around the table situated in the middle.

Abbreviations

AGC	Automatic Gain Control	GSM	Global System for Mobile communications
BER	Bit-Error Rate	IC	Integrated Circuit
C/I	Carrier-to-Interference ratio	ICI	Inter-Carrier Interference
C/N	Carrier-to-Noise ratio	IF	Intermediate-Frequency
COFDM	Coded Orthogonal Frequency Division Multiplex	LVDS	Low-Voltage Differential Signalling
DAB	Digital Audio Broadcasting (Eureka-147)	MER	Modulus Error Ratio
DSL	Digital Subscriber Line	MRC	Maximum Ratio Combining (algorithm)
DTT	Digital Terrestrial Television	PER	Packet Error Rate
DTV	Digital Television	PID	(MPEG) Packet IDentification number
DVB	Digital Video Broadcasting	QAM	Quadrature Amplitude Modulation
DVB-T	DVB - Terrestrial	QEF	Quasi-Error-Free
FEC	Forward Error Correction	QoS	Quality of Service
ESR₅	Erroneous Second Ratio, 5%	RF	Radio-Frequency
ETSI	European Telecommunication Standards Institute	R-S	Reed-Solomon
FFT	Fast Fourier Transform	SAW	Surface Acoustic Wave
GPS	Global Positioning System	SFN	Single-Frequency Network
		TS	(MPEG) Transport Stream
		TTL	Transistor-to-Transistor Logic

The influence of an active antenna comes from the low noise figure of its amplifier which can improve the sensitivity of the receiver. Also, interference caused by electromagnetic activity in the receiver itself are less pronounced when the amplifier is closer to the antenna. The influence of polarity comes from the gain (3 to 4 dB more when using the correct polarity) and the quality of the signal expressed by the *C/I* loss due to interference present on the other polarity that does not exist on the good polarity.

In any case, diversity reception offers the best solution by far, not only in terms of indoor coverage but also robustness over time.



Figure 8
Comparison between different types of antennas and diversity reception in portable indoor situations:
transmitter antenna polarization = horizontal

Laboratory measurements

Description of the DVB-T channel simulator for diversity measurements

To test diversity receivers, two or more RF signals are applied to the various antenna inputs. To represent realistic conditions (as experienced in the field), these signals need to be synchronized in frequency and to transmit identical data, i.e. they have to maintain *bit synchronization*. On the other hand, the RF signals must be uncorrelated to simulate the situation where the distance between the various antennas is more than half the wavelength of the RF signal.

Rohde & Schwarz modified their Test Signal Generator SFQ in such a way that it became possible to use the same channel encoder with several up-converters and independent channel simulators. *Fig. 9* shows a block diagram of a Diversity2 simulator using two “SFQs”

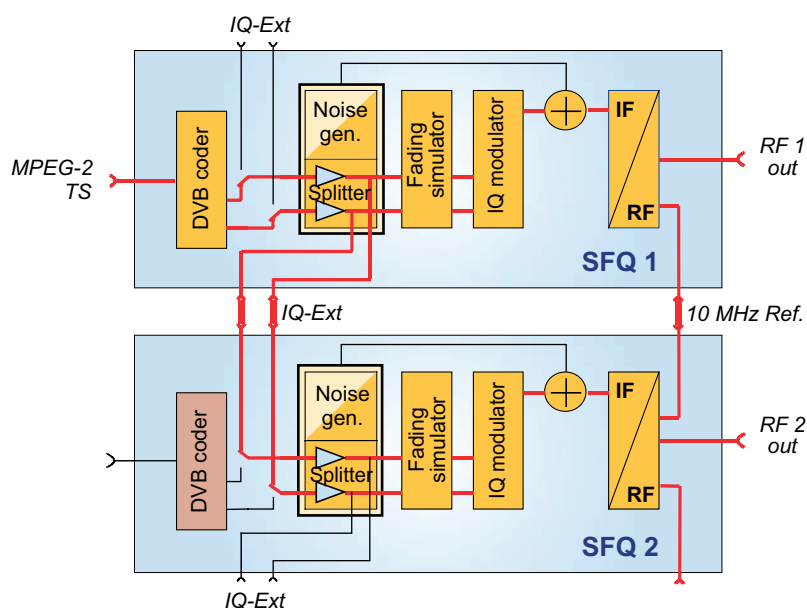

Figure 9
Test set-up for Diversity2 measurements

Bit synchronization is guaranteed because only one DVB-T channel encoder is used whose I/Q output signals are fed into two or more units. Suitable 0-dB splitters are used to offer the possibility of extending this test set-up to four or even more synchronized but uncorrelated RF signals. Since the internal generation of the simulated distortions caused by fading is free-running with undefined starting points, these fading patterns produce uncorrelated RF signals. The RF output frequencies are synchronized by means of a master clock, running at 10 MHz, that is taken from one instrument and distributed to all others.

Channel profiles

Two channel profiles have been selected to reproduce the DVB-T service delivery situation in a mobile environment. They reproduce the characteristics of the terrestrial channel propagation with a single transmitter.

○ Typical Urban reception (TU6)

This case corresponds to urban reception conditions as defined by a Typical Urban COST 207 profile (six paths). This channel profile has also been used for some GSM and DAB tests. However, in the case of broadband signals such as DVB-T, it corresponds to fairly *long* echoes which are similar to what can be seen in *mobile outdoor* environments.

○ Typical Rural Area reception (RA6)

This case corresponds to rural reception conditions as defined by the Typical Rural COST 207 profile (six paths). This channel profile has also been used for some GSM and DAB tests. However, in the case of broadband signals such as DVB-T, it corresponds to very *short* echoes which are similar to what can be seen with *portable indoor* reception.

Quality criteria and measurements

The transmission quality criteria used were “quasi-error-free” (QEF) for the fixed mode, and “erroneous second ratio 5%” (ESR₅) for the mobile and portable modes. QEF corresponds to a BER of $2 \cdot 10^{-4}$ after the

Viterbi decoder, and ESR_5 means there is a maximum of one erroneous second in any 20-second period, for good reception. These criteria have been developed previously within the European projects *Motivate* and *MCP* as being the most relevant for reception-quality measurement in the mobile digital TV environment.

The following table gives, for several DVB-T modes, the minimum C/N values required for good fixed, mobile and portable reception, comparing the values for single and diversity reception.

Modulation	$(C/N)_{min}$ Fixed		$(\overline{C/N})_{min}$ Mobile TU6 10 Hz		$(\overline{C/N})_{min}$ Portable RA6 10 Hz	
	Single	Diversity	Single	Diversity	Single	Diversity
16-QAM 1/2	9 dB	6 dB	18.5 dB	12 dB		
16-QAM 2/3	11 dB	8 dB	21.5 dB	15 dB	24 dB	16.5 dB
16-QAM 3/4	13 dB	10 dB	24 dB	16.5 dB		
64-QAM 2/3	17 dB	14 dB	27.5 dB	19 dB	30 dB	22 dB

It can be seen that, in single-mode reception, the average C/N required for portable DVB-T reception is 13 dB greater than the level required for fixed reception while, for mobile reception, the extra C/N required is about 10 dB. It can also be seen that diversity reception offers an average C/N improvement of about 7 dB compared with single-mode reception, in the case of both mobile and portable reception. In order to understand what these values mean in the field, we measured and subsequently analysed the C/N values found in areas of sufficient field strength in several countries. Our findings are discussed in the next section.

Statistical analysis

In this analysis, we acquired several 1000-second recordings of DVB-T mobile reception at low speeds, in an area where the received field strength was above the sensitivity level of the receiver. Then, we looked at the ratio of seconds that had no errors. These measurements were done with a receiver that provided simultaneous single and diversity mode functions, i.e. at the same location and at the same time.

The following table summarizes the information that was collected. Note how diversity reception not only brings about coverage improvements – it also increases the maximum Doppler frequency that can be reached in the different DVB-T modulation modes.

Country / city	Modulation	Bitrate (Mbit/s)	Single		Diversity		Diversity / Single
			Coverage (%)	Doppler max. (Hz)	Coverage (%)	Doppler max. (Hz)	Coverage cell area
Taiwan	16-QAM 1/2, 8K	10 - 12	99	65	100	80	x2 - x4
Köln (DE)	16-QAM 2/3, 8K	13 - 16	98	60	99	80	x2 - x4
Berlin (DE)	16-QAM 3/4, 8K	15 - 18	85	50	99	75	x2 - x4
UK	16-QAM 3/4, 2K	15 - 18	85	120 (40 for C/N = 26 dB)	95	300	x2 - x4

France, Spain, Netherlands	64-QAM 2/3, 8K	20 - 24	55	35	98	65	x2 - x4
-------------------------------	-------------------	---------	----	----	----	----	---------

The conclusion from this analysis is that, for bitrates lower than that offered by 16-QAM 2/3, the DVB-T system offers fairly good coverage even in single mode, although the maximum Doppler frequency (in the case of mobile usage) is lower in single mode. In the field, an average C/N of 20 dB was observed for 16-QAM 2/3, compared with 21 dB required for mobile and 24 dB required for portable reception, as described above.

For bitrates higher than 16-QAM 2/3, the diversity mode offers a significant advantage in terms of coverage over the single mode. Typically, in France and the Netherlands (64-QAM 2/3), mobile and portable coverage using diversity reception is as good (> 98%) as single reception in the case of the lower modulation modes.

In the UK, the C/N degradation is often due to interference caused by the dense occupancy of the UHF spectrum. This may affect one path more than another, thus offering inferior mobile diversity coverage (95%) than in the other countries tested (98 to 100%).



Yannick Lévy received his engineering degree from the Ecole Supérieure d'Electricité in Paris, France, and a Ph.D. from the University of Notre Dame in Notre Dame, USA, in error control coding. Upon his return to France, he joined the Signal Processing group of Sagem in Paris. During that time, he was the DVB editor of the ETS 300 800 specification for interactivity over cable networks which was adopted by ETSI in September 1997.

In 1998, Dr Lévy joined Atmel Corporation where he was manager of the design and marketing team created in Paris by himself and other engineers from Sagem, and produced a complete Digital QAM cable receiver integrated circuit. In June 2000, he founded DiBcom, a company specializing in mobile and portable reception of TV and data. He is currently acting as President and Chief Executive Officer of DiBcom.

Website: <http://www.dibcom.net>

Conclusions

As DVB-T transmission costs are more expensive than with other types of infrastructure, portable and mobile DTV services must be included by broadcasters in their business strategies. This article has shown that, irrespective of which DVB-T mode has been selected, there is a way to offer good portable and mobile reception – *diversity reception*.

The extra costs relating to the implementation of diversity receivers will decrease with time. Today, many portable indoor TV antennas have multiple “whips” for analogue reception. Assuming these whips are connected to a two-path diversity DTV receiver, the extra cost incurred is simply that of one additional tuner and one DVB-T chip.

Looking back just a few years, it took no less than four integrated circuits to be able to receive a single DVB terrestrial signal whereas, today, single-chip solutions now exist for the complete set-top box (STB). It is almost certain that diversity will soon be a required feature on all DTV receivers and STBs. Therefore, it is time to start using DVB-T for one of its best features: *portability* and *mobility* ... watch TV anywhere!