



**Broadcast and On-line Services: Search, select, and
rightful use of content on personal storage systems
("TV-Anytime");
Part 3: Metadata;
Sub-part 3: Phase 2 - Extended Metadata Schema**

EBU
OPERATING EUROVISION

Reference

RTS/JTC-TVA-PH2-66-03-03

Keywords

broadcasting, content, data, TV, video

ETSI

650 Route des Lucioles
F-06921 Sophia Antipolis Cedex - FRANCE

Tel.: +33 4 92 94 42 00 Fax: +33 4 93 65 47 16

Siret N° 348 623 562 00017 - NAF 742 C
Association à but non lucratif enregistrée à la
Sous-Préfecture de Grasse (06) N° 7803/88

Important notice

Individual copies of the present document can be downloaded from:

<http://www.etsi.org>

The present document may be made available in more than one electronic version or in print. In any case of existing or perceived difference in contents between such versions, the reference version is the Portable Document Format (PDF). In case of dispute, the reference shall be the printing on ETSI printers of the PDF version kept on a specific network drive within ETSI Secretariat.

Users of the present document should be aware that the document may be subject to revision or change of status. Information on the current status of this and other ETSI documents is available at

<http://portal.etsi.org/tb/status/status.asp>

If you find errors in the present document, please send your comment to one of the following services:

http://portal.etsi.org/chaicor/ETSI_support.asp

Copyright Notification

No part may be reproduced except as authorized by written permission.
The copyright and the foregoing restriction extend to reproduction in all media.

© European Telecommunications Standards Institute 2012.

© European Broadcasting Union 2012.

All rights reserved.

DECT™, **PLUGTESTS™**, **UMTS™** and the ETSI logo are Trade Marks of ETSI registered for the benefit of its Members.
3GPP™ and **LTE™** are Trade Marks of ETSI registered for the benefit of its Members and
of the 3GPP Organizational Partners.

GSM® and the GSM logo are Trade Marks registered and owned by the GSM Association.

Contents

Intellectual Property Rights	5
Foreword.....	5
Introduction	6
1 Scope	7
2 References	8
2.1 Normative references	8
2.2 Informative references.....	9
3 Definitions and abbreviations.....	9
3.1 Definitions	9
3.2 Abbreviations	11
4 <i>TV-Anytime</i> metadata data model.....	12
4.1 <i>TV-Anytime</i> metadata process model.....	12
4.2 <i>TV-Anytime</i> metadata structure model.....	13
4.3 CRID and metadata	14
5 Metadata definitions	15
5.1 Introduction	15
5.2 Use of MPEG-21	15
5.3 <i>TV-Anytime</i> metadata namespace	15
6 Phase 2 basic types	16
6.1 New content types	16
6.1.1 Content attributes base type	16
6.1.1.1 Audio attributes	16
6.1.1.2 Video attributes	17
6.1.1.3 Still image content attributes.....	18
6.1.2 Context attributes base type	19
6.1.2.1 Data broadcasting context	19
6.1.2.2 Interstitial context	20
6.1.2.3 Educational context	20
6.1.2.4 Application context	21
6.1.2.5 Game context attributes.....	22
6.1.3 Content properties datatype	22
6.2 Targeting information.....	24
6.2.1 Biographic information.....	25
6.2.2 Accessibility information.....	26
6.2.3 User information.....	27
6.2.4 Terminal information.....	28
6.2.5 Network information.....	32
6.2.6 Natural environment information	33
6.2.7 Usage environment description table.....	35
6.2.8 TargetingInformationType.....	36
6.3 Coupon description.....	39
6.4 Extended purchase item description	43
7 Extensions to programme description datatypes	44
7.1 Extended basic content description datatype.....	44
7.2 Extended instance description	46
7.3 Extended segment description	47
7.4 Extended related material type	48
7.5 Extended service information type.....	49
8 Content package description	49
8.1 Introduction	49
8.2 Declarations.....	50

8.3	Descriptor	51
8.4	Item	52
8.5	Component	58
8.6	Package	61
9	Extended user description datatypes	62
10	Information tables	63
10.1	Package table.....	63
10.2	Interstitial campaign table	63
10.3	Rights Management and Protection Information (RMPI) table.....	64
10.4	Coupon table	65
10.5	Targeting information table.....	65
11	Extended <i>TV-Anytime</i> information document	66
Annex A (normative): TV-Anytime classification schemes		67
A.1	Introduction	67
A.2	Game Perspectives CS.....	68
A.3	Intended Educational User CS	69
A.4	Educational Use CS.....	69
A.5	Family Member CS	70
A.6	Accessibility CS	73
A.7	CPU Type CS	74
A.8	Operating system CS	76
A.9	Virtual Machine CS.....	79
A.10	Other System Software CS.....	80
A.11	Middleware Service CS.....	81
A.12	Terminal Type CS	82
A.13	Place Type CS	85
A.14	Weather Type CS	89
A.15	Temporal Relation CS.....	90
A.16	Spatial Relation CS	92
A.17	Content Type CS	93
A.18	Checksum Algorithm CS.....	94
Annex B (normative): TV-Anytime extended description schemes and classification schemes.....		95
History		98

Intellectual Property Rights

IPRs essential or potentially essential to the present document may have been declared to ETSI. The information pertaining to these essential IPRs, if any, is publicly available for **ETSI members and non-members**, and can be found in ETSI SR 000 314: *"Intellectual Property Rights (IPRs); Essential, or potentially Essential, IPRs notified to ETSI in respect of ETSI standards"*, which is available from the ETSI Secretariat. Latest updates are available on the ETSI Web server (<http://ipr.etsi.org>).

Pursuant to the ETSI IPR Policy, no investigation, including IPR searches, has been carried out by ETSI. No guarantee can be given as to the existence of other IPRs not referenced in ETSI SR 000 314 (or the updates on the ETSI Web server) which are, or may be, or may become, essential to the present document.

Foreword

This Technical Specification (TS) has been produced by Joint Technical Committee (JTC) Broadcast of the European Broadcasting Union (EBU), Comité Européen de Normalisation ELECTrotechnique (CENELEC) and the European Telecommunications Standards Institute (ETSI).

NOTE: The EBU/ETSI JTC Broadcast was established in 1990 to co-ordinate the drafting of standards in the specific field of broadcasting and related fields. Since 1995 the JTC Broadcast became a tripartite body by including in the Memorandum of Understanding also CENELEC, which is responsible for the standardization of radio and television receivers. The EBU is a professional association of broadcasting organizations whose work includes the co-ordination of its members' activities in the technical, legal, programme-making and programme-exchange domains. The EBU has active members in about 60 countries in the European broadcasting area; its headquarters is in Geneva.

European Broadcasting Union
 CH-1218 GRAND SACONNEX (Geneva)
 Switzerland
 Tel: +41 22 717 21 11
 Fax: +41 22 717 24 81

The present document is part 3, sub-part 3 of a multi-part deliverable covering Broadcast and On-line Services: Search, select and rightful use of content on personal storage systems ("*TV-Anytime*"), as identified below:

- Part 1: " Benchmark Features";
- Part 2: "Phase 1 - System description";
- Part 3: "Metadata":**
 - Sub-part 1: "Phase 1 - Metadata schemas";
 - Sub-part 2: "System aspects in a uni-directional environment";
 - Sub-part 3: "Phase 2 - Extended Metadata Schema";**
 - Sub-part 4: "Phase 2 - Interstitial metadata";
- Part 4: "Phase 1 - Content referencing";
- Part 5: " Rights Management and Protection (RMP)";
- Part 6: "Delivery of metadata over a bi-directional network";
- Part 7: " Bi-directional metadata delivery protection";
- Part 8: "Phase 2 - Interchange Data Format";
- Part 9: "Phase 2 - Remote Programming".

Introduction

The present document is based on a submission by the *TV-Anytime* forum (<http://tech.ebu.ch/tvanytime>).

"*TV-Anytime*" (TVA) is a full and synchronized set of specifications established by the *TV-Anytime* Forum. TVA features enable the search, selection, acquisition and rightful use of content on local and/or remote personal storage systems from both broadcast and online services.

TS 102 822-1 [1] and TS 102 822-2 [2] set the context and system architecture in which the standards for Metadata, Content referencing, Bi-directional metadata and Metadata protection are to be implemented in the *TV-Anytime* environment. TS 102 822-1 [1] provides benchmark business models against which the *TV-Anytime* system architecture is evaluated to ensure that the specification enable key business applications. TS 102 822-2 [2] presents the *TV-Anytime* System Architecture. These two documents are placed ahead of the others for their obvious introductory value. These first two documents are largely informative, while the remainder of the series is normative.

The features are supported and enabled by the specifications for Metadata (TS 102 822-3-1 [3], TS 102 822-3-2 [4], TS 102 822-3-3 (the present document) and TS 102 822-3-4 [5]), Content Referencing (TS 102 822-4 [6]), Rights Management (TS 102 822-5-1 [7] and TS 102 822-5-2 [8]), Bi-directional Metadata Delivery (TS 102 822-6-1 [9], TS 102 822-6-2 [10] and TS 102 822-6-3 [11]) and Protection (TS 102 822-7 [12]), Interchange Data Format (TS 102 822-8 [13]) and Remote Programming (TS 102 822-9 [14]).

The present document addresses more specifically the Phase 2 extended metadata features of the *TV-Anytime* specification as identified in TS 102 822-1 [1].

1 Scope

The present document is part of *TV-Anytime* Phase 2 that proposes an evolutionary range of features which describe PDR (Personal Digital Recorder) usage models that the *TV-Anytime* standards facilitate. The *TV-Anytime* specifications enable search, select, acquire and rightful use of content on local and/or remote personal storage systems from both broadcast and online services.

The features are supported and enabled by the specifications for Metadata (TS 102 822-3-1 [3], TS 102 822-3-2 [4], the present document and TS 102 822-3-4 [5]), Content Referencing (TS 102 822-4 [6]), Rights Management (TS 102 822-5-1 [7] and TS 102 822-5-2 [8]), Bi-directional Metadata Delivery (TS 102 822-6-1 [9], TS 102 822-6-2 [10] and TS 102 822-6-3 [11]) and Protection (TS 102 822-7 [12]), Interchange Data Format (TS 102 822-8 [13]) and Remote Programming (TS 102 822-9 [14]).

The present document addresses more specifically the Phase 2 extended metadata features of the *TV-Anytime* specification as identified in TS 102 822-1 [1].

Metadata is generally defined as "data about data". Within the *TV-Anytime* environment, the most visible parts of metadata are the attractors/descriptors or hyperlinks used in Electronic Programme Guides, or in Web pages. This is the information that the consumer or agent will use to decide whether or not to acquire a particular piece of content.

The *TV-Anytime* metadata system allows the consumer to find, navigate and manage content from a variety of internal and external sources including, for example, enhanced broadcast, interactive TV, Internet and local storage. It defines a standard way to describe device profiles, consumer preferences to facilitate automatic filtering and acquisition of content by agents on behalf of the consumer. Consumers, as used in the present document, include educators and students, who may use selected programme segments in the classroom or laboratory.

There is a need to associate metadata with content to facilitate human and automated searching for content of interest. Such metadata includes descriptive elements and attractors to aid the search process as well as elements essential to the acquisition, capture and presentation processes; content rights, formats, duration, etc. Many of these descriptive elements can be found in EPGs and HTML documents.

The process of creation and evolution of metadata for an individual content item may involve many organizations during the course of creation, distribution and delivery to the consumer. Thus, there is a clear need to define a common metadata framework and a standard set of metadata elements in order to ensure a high level of interoperability within the chain from content creation to content delivery.

TV-Anytime Phase 2 extends the definition of *TV-Anytime* Phase 1 metadata to cover descriptive data about content, such as content title and synopsis, but also data about how the content should be consumed. Such metadata is called "attractors" because they can attract a consumer to content. Attractors allow consumers to find, navigate and manage content from various sources. New Phase 2 attractors include:

- Content Packaging.
- Targeting metadata.
- Device Capabilities.
- Interstitial Content.
- New Content Type.

The formal definitions of metadata schemas should be read in conjunction with the system specification defining how they could be used in an end-to-end system *TV-Anytime* only defines the metadata format for metadata that may be exchanged between various entities such as between the content provider and consumer, among consumers or between a third-party metadata provider and the consumer.

XML [15] is the "representation format" used to define the schemas of the *TV-Anytime* Metadata Specification. Although XML Schema is used to define how metadata is represented in XML, it can also be used to describe equivalent, non-XML representations of the same metadata.

2 References

References are either specific (identified by date of publication and/or edition number or version number) or non-specific. For specific references, only the cited version applies. For non-specific references, the latest version of the reference document (including any amendments) applies.

Referenced documents which are not found to be publicly available in the expected location might be found at <http://docbox.etsi.org/Reference>.

NOTE: While any hyperlinks included in this clause were valid at the time of publication, ETSI cannot guarantee their long term validity.

2.1 Normative references

The following referenced documents are necessary for the application of the present document.

- [1] ETSI TS 102 822-1: "Broadcast and On-line Services: Search, select, and rightful use of content on personal storage systems ("TV-Anytime"); Part 1: Benchmark Features".
- [2] ETSI TS 102 822-2: "Broadcast and On-line Services: Search, select, and rightful use of content on personal storage systems ("TV-Anytime"); Part 2: Phase 1 - System description".
- [3] ETSI TS 102 822-3-1: "Broadcast and On-line Services: Search, select, and rightful use of content on personal storage systems ("TV-Anytime"); Part 3: Metadata; Sub-part 1: Phase 1 -Metadata schemas".
- [4] ETSI TS 102 822-3-2: "Broadcast and On-line Services: Search, select, and rightful use of content on personal storage systems ("TV-Anytime"); Part 3: Metadata; Sub-part 2: System aspects in a uni-directional environment".
- [5] ETSI TS 102 822-3-4: "Broadcast and On-line Services: Search, select, and rightful use of content on personal storage systems ("TV-Anytime"); Part 3: Metadata; Sub-part 4: Phase 2 - Interstitial metadata".
- [6] ETSI TS 102 822-4: "Broadcast and On-line Services: Search, select, and rightful use of content on personal storage systems ("TV-Anytime"); Part 4: Phase 1 - Content referencing".
- [7] ETSI TS 102 822-5-1: "Broadcast and On-line Services: Search, select, and rightful use of content on personal storage systems ("TV-Anytime"); Part 5: Rights Management and Protection (RMP) Sub-part 1: Information for Broadcast Applications".
- [8] ETSI TS 102 822-5-2: "Broadcast and On-line Services: Search, select, and rightful use of content on personal storage systems ("TV-Anytime"); Part 5: Rights Management and Protection (RMP) Sub-part 2: RMPI binding".
- [9] ETSI TS 102 822-6-1: "Broadcast and On-line Services: Search, select, and rightful use of content on personal storage systems ("TV-Anytime"); Part 6: Delivery of metadata over a bi-directional network; Sub-part 1: Service and transport".
- [10] ETSI TS 102 822-6-2: "Broadcast and On-line Services: Search, select, and rightful use of content on personal storage systems ("TV-Anytime"); Part 6: Delivery of metadata over a bi-directional network; Sub-part 2: Phase 1 - Service discovery".
- [11] ETSI TS 102 822-6-3: "Broadcast and On-line Services: Search, select, and rightful use of content on personal storage systems ("TV-Anytime"); Part 6: Delivery of metadata over a bi-directional network; Sub-part 3: Phase 2 - Exchange of Personal Profile".
- [12] ETSI TS 102 822-7: "Broadcast and On-line Services: Search, select, and rightful use of content on personal storage systems ("TV-Anytime Phase 1"); Part 7: Bi-directional metadata delivery protection".
- [13] ETSI TS 102 822-8: "Broadcast and On-line Services: Search, select, and rightful use of content on personal storage systems ("TV-Anytime"); Part 8: Phase 2 - Interchange data format".

- [14] ETSI TS 102 822-9: "Broadcast and On-line Services: Search, select, and rightful use of content on personal storage systems ("TV-Anytime"); Part 9: Phase 2 - Remote Programming".
- [15] XML Schema, W3C Recommendations (version 20010502).
- NOTE: Available at:
<http://www.w3.org/TR/2001/REC-xmlschema-0-20010502>.
<http://www.w3.org/TR/2001/REC-xmlschema-1-20010502>.
<http://www.w3.org/TR/2001/REC-xmlschema-2-20010502>.
- [16] ISO/IEC 15938-5 (2003): "Information technology -- Multimedia content description interface -- Part 5: Multimedia description schemes".
- [17] ISO/IEC 15938-2 (2002): "Information technology -- Multimedia content description interface -- Part 2: Description definition language".
- [18] ISO/IEC 21000-2 (2005): "Information technology -- Multimedia framework (MPEG-21) -- Part 2: Digital Item Declaration".
- [19] ISO/IEC 21000-7 (2007): "Information technology -- Multimedia framework (MPEG-21) -- Part 7: Digital Item Adaptation".
- [20] ISO/IEC 15938 (all parts): "Information technology -- Multimedia content description interface".
- [21] ISO/IEC 21000 (all parts): "Information technology -- Multimedia framework (MPEG-21)".

2.2 Informative references

The following referenced documents are not necessary for the application of the present document but they assist the user with regard to a particular subject area.

- [i.1] IEEE 802.3: "Ethernet".
- [i.2] ITU-T Recommendation V.42: "Error-correcting procedures for DCEs using asynchronous-to-synchronous conversion".
- [i.3] ISO 3309 (1991): "High-Level Data Link Control (HDLC) -- Frame Structure".
- [i.4] ECMA-182: "Data Interchange on 12,7 mm 48-Track Magnetic Tape Cartridges - DLT1 Format".

3 Definitions and abbreviations

3.1 Definitions

For the purposes of the present document, the following terms and definitions apply:

application: specific set of functions running on the PDR

NOTE: Some applications use metadata, either automatically or under consumer control.

attractor: metadata element that is accessible by the consumer in order to aid in the content selection process, thus attracting the consumer

EXAMPLE: Title and name of an actor in a television programme.

content: anything the consumer would like to access and that can be stored on a PDR

content creator: producers of the content

content item: entity that can be acquired as a single unit

EXAMPLE: AV file, Audio stream.

content package: collection of content items, which may be consumed as a whole or individually

content provider: entity that acts as the agent for and is the prime exploiter of the content

content reference: pointer to a specific content item

description scheme: formal definition of a metadata schema written in the MPEG-7 Description Definition Language (DDL)

NOTE: See ISO/IEC 15938-2 [17].

descriptor: metadata element, such as an attractor or other information about content such as the key frame index of a piece of video

enhanced TV: television that includes additional information and/or applications related to content, but does not use a return path

interactive TV: television that includes additional information and/or applications related to content and which takes advantage of a return path

interstitial: material shown between programme elements in a linear stream

NOTE: Interstitials can comprise advertising, station idents, promotional material, graphics, etc.

life cycle: process of creation, usage, storage, and deletion of metadata

location resolution: process of establishing the address (location and time) of a specific content instance from its CRID

metadata: data about content

EXAMPLE: The title, genre and summary of a television programme.

NOTE: In the context of *TV-Anytime*, metadata also includes consumer profile and history data.

metadata schema: identifier associated with a set of XML schemas that globally identifies those schemas so that they can be referenced externally

NOTE: A globally unique namespace ensures that the names of types defined by schemas in that namespace do not conflict with types of the same name defined elsewhere.

metadata system: set of rules describing the syntax and semantics of metadata

MPEG-7: generic name of the ISO/IEC 15938 [20] set of standards for content-related metadata applicable to a broad range of applications

MPEG-21: generic name of the ISO/IEC 21000 [21] set of standards defining a framework for multimedia digital items

namespace: collection of components that allows the end-to-end operation of the *TV-Anytime* metadata solution

programme: editorially coherent piece of content

NOTE: Typically, a programme is acquired by the PDR as a whole.

programme group: one or more programmes that are grouped together

NOTE: *TV-Anytime* defines several types of programme groups such as "series" and "programme compilation".

provider: entity that delivers content or services to the PDR

return path: part of a bi-directional distribution system over which data flows from the consumer to the service provider

spot: short video sequences

NOTE: This format is predominantly used for advertising and promotional material.

targeting: process which allows providers to deliver relevant content to specific individuals or groups of individuals

3.2 Abbreviations

For the purposes of the present document, the following abbreviations apply:

AV Audio-Visual
CRID Content Reference IDentifier

NOTE: As defined in TS 102 822-4 [6], it is an identifier for content that is independent of its location.

CS Classification Scheme
DDL Description Definition Language

NOTE: The language used to define description schemes in MPEG-7 (see ISO/IEC 15938-2 [17]).

DIA Digital Item Adaptation
DID Digital Item Declaration
EPG Electronic Programme Guide

NOTE: A means of presenting available content to the consumer, allowing selection of desired content.

HTML HyperText Markup Language
IPR Intellectual Property Rights
PDR Personal Digital Recorder
RMPI Rights Management and Protection Information
TVA *TV-Anytime*
XML eXtensible Markup Language

4 TV-Anytime metadata data model

4.1 TV-Anytime metadata process model

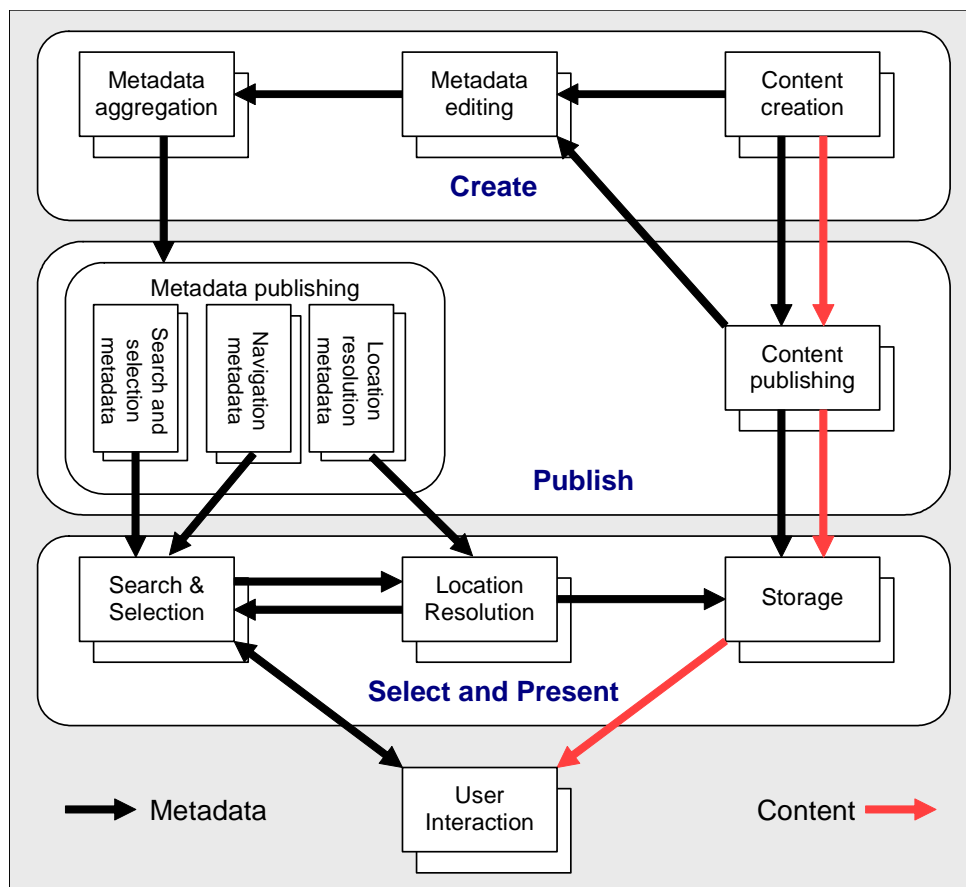

Figure 1: Metadata and content flow

Figure 1 shows the flow of metadata and content through various stages of creation and delivery to the end consumer.

This model clearly identifies the separation of the processing of metadata and content while at the same time illustrating the parallels between the processing of metadata and content.

Content creation

The content creation process represents the production of a piece of content. During the production process, the content is created and information about the content may also be captured. At this stage, however, the metadata is unlikely to be in a form that can be directly exposed to a user - some form of editing will be required before the description of the content can be published.

Content publishing

Once content has been created, the content is then available for publication by a content publisher. This could be, for example, as part of a broadcast service or as a publication on the Internet. The content publishing process defines instantiations of content items - in other words, one output from the content publishing process is information about "where" the content can be found. In the broadcast case, this means a schedule for the services that are published.

Metadata editing

The metadata editing process takes *raw* information from the content creation and publishing processes and edits this into a form that is suitable for representing the content to the end consumer. The output of this process is edited metadata for the content and/or metadata describing the location of the content.

Metadata aggregation

In order to support a given *TV-Anytime* system, it is likely that metadata from a number of independent content creators and publishers will need to be aggregated. It is important to recognize that the process of metadata aggregation may result in the original metadata being changed.

Metadata publishing

Without prejudice to whether or not a *TV-Anytime* system is horizontally or vertically integrated, an aggregated metadata set will need to be published to both the content selection and location resolution processes. The content selection process will be largely concerned with the metadata describing content but may also involve use of the content location information. The location resolution service will simply require information about the location of programmes.

Content selection

The content selection process may occur through the direct involvement of the consumer or may be performed on the consumer's behalf by a software agent. In order for a software agent to function correctly, metadata describing the consumer, his receiver and his preferences will need to be provided to the content selection process. This may be either inferred from the consumer's past history of content selection or by the explicit specification of preferences by the user (or a combination of the two). The content selection process may be, in part, affected by knowledge of the contents location.

Location resolution

The process of location resolution is simply one of discovering where (or when) a content item can be found. Details of this discovery process can be found in the TS 102 822-4 [6].

4.2 *TV-Anytime* metadata structure model

Two modelling approaches are used in the following clauses.

A simple data modelling methodology is shown in figure 2 that allows to describe metadata structures at a high level in a manner independent of any particular representation. This syntax allows relationships between *TV-Anytime* entities to be clearly stated (e.g. one-to-many), as well as enabling the powerful concept of inheritance, which allows specific types of entity to be derived from generic types.

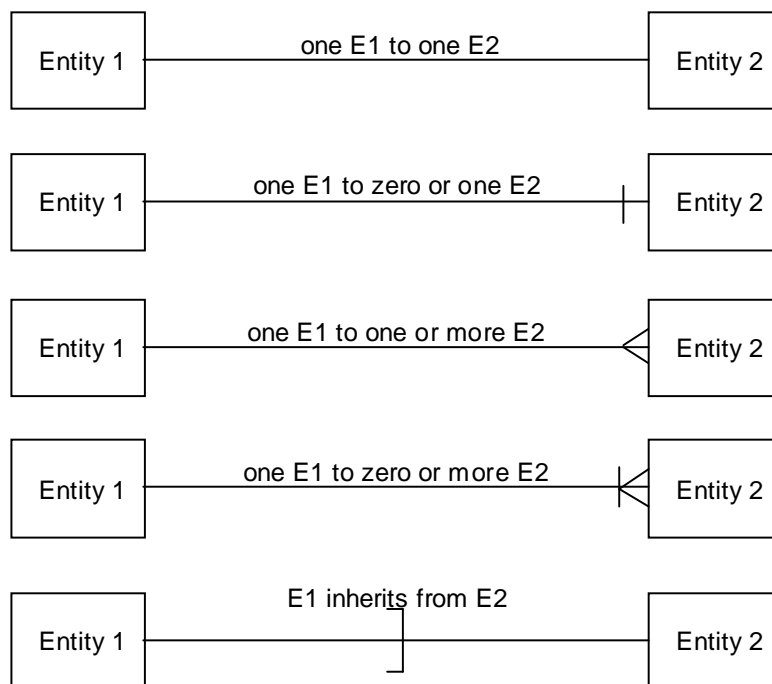

Figure 2: Basic entity-relation graph syntax

The other modelling approach followed by *TV-Anytime* is the representation of the metadata schemas using a UML-like (Unified Modelling Language) language defined in more details in annex D of TS 102 822-3-1 [3].

4.3 CRID and metadata

The cornerstone of *TV-Anytime* metadata is the CRID [6]. As a content reference identifier, a CRID refers to a piece of content, though in some cases it may refer to one or more other CRIDs.

The CRID also acts as the link that connects different content-related metadata descriptions.

Content-related metadata is classified as either *content description metadata*, *instance description metadata* or *package description metadata*.

Content description metadata is general information about a piece of content that does not change regardless of how the content is published or broadcast. It includes information such as the content's title, textual description, and genre. Typically, the content creator assigns content description metadata before publication.

Instance description metadata describes a particular instance of a piece of content, including information such as the content location, usage rules (pay-per-view, etc.), and delivery parameters (e.g. video format). Instance description metadata is assigned by the content provider as a part of the publication of content.

Package description metadata enables the device or consumer to make choices about which components that make up the content are acquired. In addition it describes the way in which the individual components making up the content should be consumed.

During the search and selection process, a consumer may use general *content description*, *instance description* and *package description* metadata.

A fourth category of metadata called *device capabilities metadata* provides a standardized way of defining the capabilities of the receiving device like Codec support, return path, etc.

5 Metadata definitions

5.1 Introduction

For the purpose of interoperability, *TV-Anytime* has adopted XML [15] as the common representation format for metadata. XML offers many advantages: it allows for extensibility, supports the separation of data from the application, and is widely used. XML schema is mainly used to represent the data model. *TV-Anytime* descriptions may however be instantiated in a format other than textual. *TV-Anytime* has described some of these mechanisms such as binary encoding in TS 102 822-3-2 [4].

5.2 Use of MPEG-21

In the areas of content packages and targeting the specification makes use of existing data types defined by MPEG-21. In particular types are borrowed from the Digital Declaration (DID) specification [18], and Digital Item Adaptation (DIA) specification [19].

5.3 *TV-Anytime* metadata namespace

TV-Anytime metadata description schemes are associated with the *TV-Anytime* metadata XML namespace. The *TV-Anytime* Phase 2 metadata namespace is defined as:

```
xmlns:tva2="urn:tva:metadata:extended:2012"
```

TV-Anytime Phase 1 metadata namespace is defined as:

```
xmlns:tva="urn:tva:metadata:2012"
<import namespace="urn:tva:metadata:2012" schemaLocation="tva_metadata_3-1_v181.xsd"/>
```

TV-Anytime metadata includes description schemes defined by XML as included in the XML stub attached to the present document.

```
xmlns="http://www.w3.org/2001/XMLSchema"
<import namespace="http://www.w3.org/XML/2001/namespace" schemaLocation="xml.xsd"/>
```

TV-Anytime also includes DSs defined by MPEG-7 as included in the MPEG7 stub attached to the present document, which use the MPEG-7 namespace as described in ISO/IEC 15938-5 [16].

```
xmlns:mpeg7="urn:tva:mpeg7:2008"
<import namespace="urn:tva:mpeg7:2008" schemaLocation="tva_mpeg7_2008.xsd"/>
```

TV-Anytime also includes description schemes defined by *TV-Anytime* for Interstitials.

```
xmlns:int="urn:tva:metadata:interstitial:2012"
<import namespace="urn:tva:metadata:interstitial:2011" schemaLocation="tva_interstitial_3-4_v161.xsd"/>
```

TV-Anytime also includes description schemes defined by MPEG-21.

```
xmlns:mpeg21="urn:tva:mpeg21:2011"
<import namespace="urn:tva:mpeg21:2011" schemaLocation="tva_mpeg21_2011.xsd"/>
```

TV-Anytime RMPI namespace is defined as:

```
xmlns:rmpi="urn:tva:rmpi:2012"
<import namespace="urn:tva:rmpi:2012" schemaLocation="tva_rmpi_5-1_v171.xsd"/>
```

6 Phase 2 basic types

6.1 New content types

Clause 6.1 contains types that may be used to describe components that are not traditional broadcast content. These content types may be standalone content items or included as part of a Package, where a Package is a collection of content grouped with a certain application scenario in the background.

The new content types are described using two sets of attributes. The first set of attributes describes properties that are inherent to a particular content item regardless of the context in which it is consumed. The second set of attributes describes properties that are context-dependent.

6.1.1 Content attributes base type

This is the abstract base type for all specific context-independent attribute types.

```
<complexType name="ContentAttributesType" abstract="true"/>
```

Name	Definition
ContentAttributesType	An abstract type to indicate content attribute according to content type.

6.1.1.1 Audio attributes

The audio attributes may be used to describe the characteristics of an audio component or audio content item.

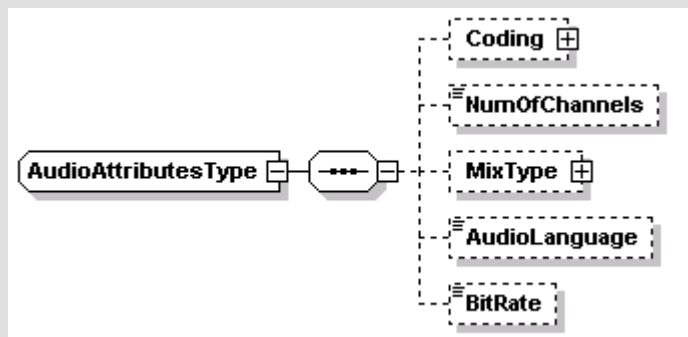

```
<complexType name="AudioAttributesType">
  <complexContent>
    <extension base="tva2:ContentAttributesType">
      <sequence>
        <element name="Coding" type="tva:ControlledTermType" minOccurs="0"/>
        <element name="NumOfChannels" type="unsignedShort" minOccurs="0"/>
        <element name="MixType" type="tva:ControlledTermType" minOccurs="0"/>
      </sequence>
    </extension>
  </complexContent>
</complexType>
```

Name	Definition
AudioAttributesType	A complex type that defines a set of elements that describes characteristics of audio content.
Coding	The coding format of the audio. This term should be taken from the MPEG-7 "AudioCodingFormatCS" classification scheme listed in clause B.2.3 of [16], i.e. AC3, DTS, MP3, MPEG-1, MPEG-2 Layer III, MPEG-2 AAC, MPEG-4, AMR.
NumOfChannels	The number of channels of audio: e.g. 1 for mono, 2 for stereo or more for multi-channel audio.
MixType	The type of the audio mix. This term should be taken from the MPEG-7 "AudioPresentationCS" Classification Scheme listed in clause B.2.6 of [16], i.e. no sound, mono, stereo, surround, home theatre 5.1 surround and movie theatre.
AudioLanguage	The spoken language of the audio.
BitRate	A complex type that defines the bitrate of the audio components/content.

6.1.1.2 Video attributes

The video attributes may be used to describe the characteristics of a video component or video content item.

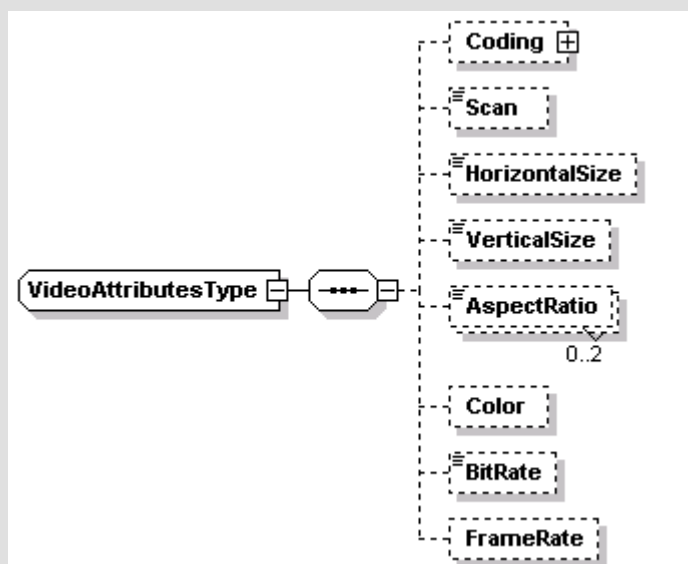

```

<complexType name="VideoAttributesType">
  <complexContent>
    <extension base="tva2:ContentAttributesType">
      <sequence>
        <element name="Coding" type="tva:ControlledTermType" minOccurs="0"/>
        <element name="Scan" type="tva:ScanType" minOccurs="0"/>
        <element name="HorizontalSize" type="unsignedShort" minOccurs="0"/>
        <element name="VerticalSize" type="unsignedShort" minOccurs="0"/>
        <element name="AspectRatio" type="tva:AspectRatioType" minOccurs="0" maxOccurs="2"/>
        <element name="Color" type="tva:ColorType" minOccurs="0"/>
        <element name="BitRate" type="tva:BitRateType" minOccurs="0"/>
        <element name="FrameRate" type="tva:FrameRateType" minOccurs="0"/>
      </sequence>
    </extension>
  </complexContent>
</complexType>

```

Name	Definition
VideoAttributesType	A complex type that defines a set of elements that describes characteristics of a video component or content.
Coding	The coding format of the video. This term should be taken from the MPEG-7 "VisualCodingFormatCS" classification scheme listed in clause B.2.34 of [16].
Scan	The scan type of the video.
HorizontalSize	The horizontal size in pixels of the video.
VerticalSize	The vertical size in pixels of the video.
AspectRatio	The aspect ratio of the video. There may be two aspect ratios associated with a programme: the original aspect ratio that the programme is available in, and the aspect ratio of a particular instance of the programme.
Color	The colour format of the video (e.g. black and white).
BitRate	A complex type that defines the bitrate of the video component/content.
FrameRate	An element expressing the frame rate of the video.

6.1.1.3 Still image content attributes

The still image content attributes may be used to describe the characteristics of a "still image" content item.

```

<simpleType name="OrientationType">
  <restriction base="nonNegativeInteger">
    <minInclusive value="0"/>
    <maxInclusive value="360"/>
  </restriction>
</simpleType>

```

```

<complexType name="StillImageContentAttributesType">
  <complexContent>
    <extension base="tva2:ContentAttributesType">
      <sequence>
        <element name="Width" type="unsignedShort" minOccurs="0" />
        <element name="Height" type="unsignedShort" minOccurs="0" />
        <element name="Orientation" type="tva2:OrientationType" minOccurs="0"/>
        <element name="IntendedUse" type="tva:ControlledTermType" minOccurs="0"
          maxOccurs="unbounded"/>
      </sequence>
    </extension>
  </complexContent>
</complexType>

```

Name	Definition
OrientationType	A simple type that is used to indicate the orientation of the original source image in degrees clockwise. It does not indicate the orientation for rendering.
StillImageContentAttributesType	A complex type that defines a set of elements that describes characteristics of a still image content.
Width	The width of the image in pixels.
Height	The height of the image in pixels.
Orientation	Indicates orientation (rotation) of the original image.
IntendedUse	A controlled term from a user-defined Classification Scheme indicating the intended use of the image.

6.1.2 Context attributes base type

This context attributes type serves as the base attribute for context specific attributes. *Context* specific attributes differ from the previously described *content* specific attributes in a way that they are dependent on the environment and the circumstances content is consumed. The context may be different for example, if a collection of travel-related information is consumed in a travel magazine (with an emphasis on entertainment), compared to the presentation of the same content in a geographic, educational programme. Such data can be provided as context attribute types.

```
<complexType name="ContextAttributesType" abstract="true"/>
```

Name	Definition
ContextAttributesType	An abstract type to indicate context attribute according to application type.

6.1.2.1 Data broadcasting context

Data broadcasting context describes context attributes specific to a data broadcasting service and its applications. A data broadcasting service provides procedural and declarative contents over broadcasting TV channel. Users can play and interact with the data broadcasting content at the set-top box connected to the broadcasting TV network.

```
<complexType name="RenderingStyleType">
  <attribute name="fullScreen" type="boolean"/>
  <attribute name="transparency" type="boolean"/>
</complexType>
```

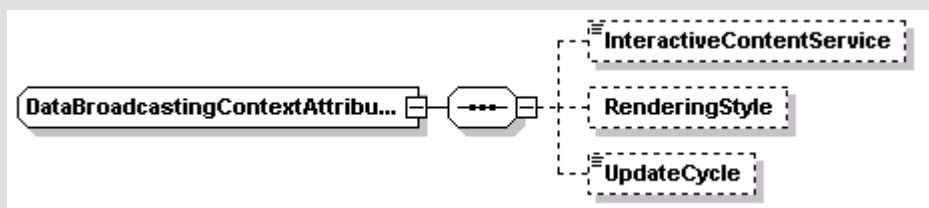

```
<complexType name="DataBroadcastingContextAttributesType">
  <complexContent>
    <extension base="tva2:ContextAttributesType">
      <sequence>
        <element name="InteractiveContentService" type="boolean" minOccurs="0"/>
        <element name="RenderingStyle" type="tva2:RenderingStyleType" minOccurs="0"/>
        <element name="UpdateCycle" type="duration" minOccurs="0"/>
      </sequence>
    </extension>
  </complexContent>
</complexType>
```

Name	Definition
RenderingStyleType	A complex type that describes rendering style of the data broadcasting service.
fullScreen	This attribute indicates whether this service is rendered on the full screen mode.
transparency	This attribute indicates whether the background of this service is transparent.
DataBroadcastingContentAttributesType	A complex type that defines a set of elements that describes characteristics of a data broadcasting content.
InteractiveContentService	This element indicates whether the service (or application/content) is interactive service (true: Two-way service, False: One-way service).
RenderingStyle	This element indicates the rendering style of the data broadcasting service.
UpdateCycle	This element indicates the update cycle of contents by using television network (0 means there is no update).

6.1.2.2 Interstitial context

The interstitial context may be used to describe the context of an interstitial content item.

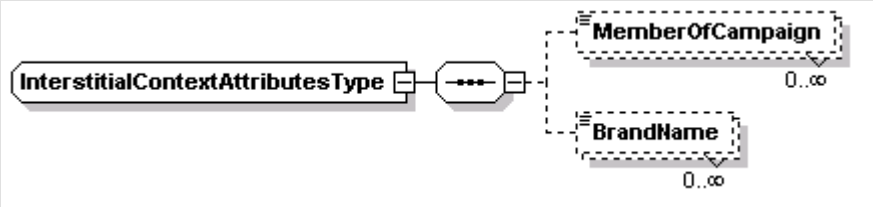

```

<complexType name="InterstitialContextAttributesType">
  <complexContent>
    <extension base="tva2:ContextAttributesType">
      <sequence>
        <element name="MemberOfCampaign" type="tva:TVAIDRefsType" minOccurs="0"
          maxOccurs="unbounded"/>
        <element name="BrandName" type="mpeg7:TextualType" minOccurs="0"
          maxOccurs="unbounded"/>
      </sequence>
    </extension>
  </complexContent>
</complexType>

```

Name	Definition
InterstitialContextAttributesType	A complex type that defines a set of elements that describes the context of the Interstitial content.
MemberOfCampaign	Identifies one or more Campaigns that this content item is a member of. The reference is to a CampaignDescription element, where details of the Campaign can be found.
BrandName	Indicates the brand being promoted within this interstitial content item.

6.1.2.3 Educational context

Content that is used in an educational context has special description requirements that are met by the EducationalContextAttributesType.

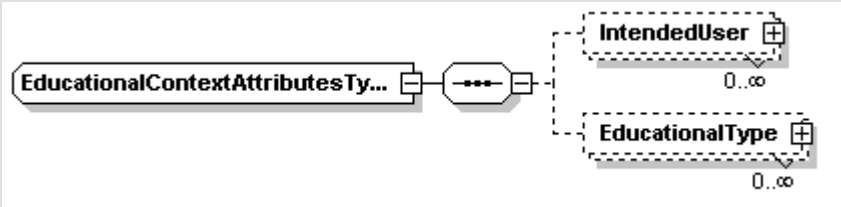

```

<complexType name="EducationalContextAttributesType">
  <complexContent>
    <extension base="tva2:ContextAttributesType">
      <sequence>
        <element name="IntendedUser" type="tva:ControlledTermType" minOccurs="0"
          maxOccurs="unbounded"/>
        <element name="EducationalType" type="tva:ControlledTermType" minOccurs="0"
          maxOccurs="unbounded"/>
      </sequence>
    </extension>
  </complexContent>
</complexType>

```

Name	Definition
EducationalContextAttributesType	A complex type that defines a set of elements that describes characteristics of content consumed in an educational context.
IntendedUser	The primary intended educational user group for a content item (e.g. school teachers). The default for controlled terminology for this datatype is the EducationalUserCS.
EducationalType	A specific kind of educational content (e.g. exercise, simulation, exam, narrative text, experiment, self assessment or lecture). The default for controlled terminology for this datatype is the EducationalUseTypeCS.

6.1.2.4 Application context

This following defines syntax and semantics to describe the feature of the application program which is a set of functions to be run on the PDR.

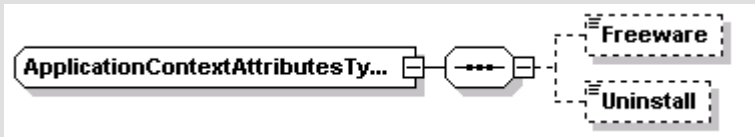

```

<complexType name="ApplicationContextAttributesType">
  <complexContent>
    <extension base="tva2:ContextAttributesType">
      <sequence>
        <element name="Freeware" type="boolean" default="true" minOccurs="0"/>
        <element name="Uninstall" type="boolean" default="false" minOccurs="0"/>
      </sequence>
    </extension>
  </complexContent>
</complexType>

```

Name	Definition
ApplicationContextAttributesType	A complex type that defines a set of elements that describes characteristics of application content.
Freeware	The value of this field is true/false. If true, the application is free.
Uninstall	This field indicates whether the application provides uninstall functionality.

6.1.2.5 Game context attributes

The following defines syntax and semantics to describe the features of game content.

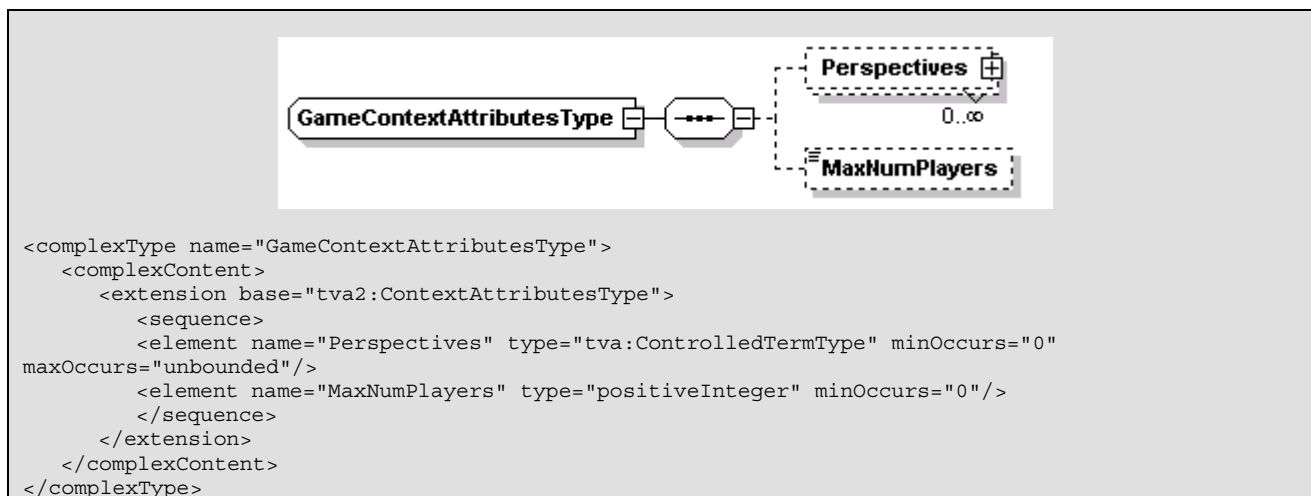

Name	Definition
GameContentAttributesType	A complex type that defines a set of elements that describes characteristics of game content.
Perspectives	Playing perspectives define the role or point of view that the player has on the game. (e.g. first-person, third-person, top-down, isometric, side-scroller, platform, and text-based). The default CS for this element, GamePerspectivesCS, can be found in clause A.2.
MaxNumPlayers	Maximal number of players who can access a game.

6.1.3 Content properties datatype

The ContentPropertiesType serves as the base element for content properties. Content properties can consist of file specific properties (described below), content attributes and context attributes.

```

<complexType name="ChecksumType">
  <simpleContent>
    <extension base="hexBinary">
      <attribute name="algorithm" type="mpeg7:termReferenceType" use="required"/>
    </extension>
  </simpleContent>
</complexType>

```

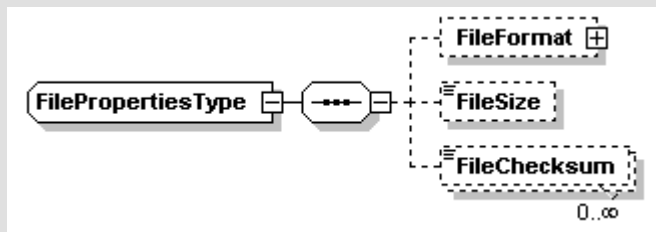

```

<complexType name="FilePropertiesType">
  <sequence>
    <element name="FileFormat" type="tva:ControlledTermType" minOccurs="0"/>
    <element name="FileSize" type="unsignedLong" minOccurs="0"/>
    <element name="FileChecksum" type="tva2:ChecksumType" minOccurs="0" maxOccurs="unbounded"/>
  </sequence>
</complexType>

```

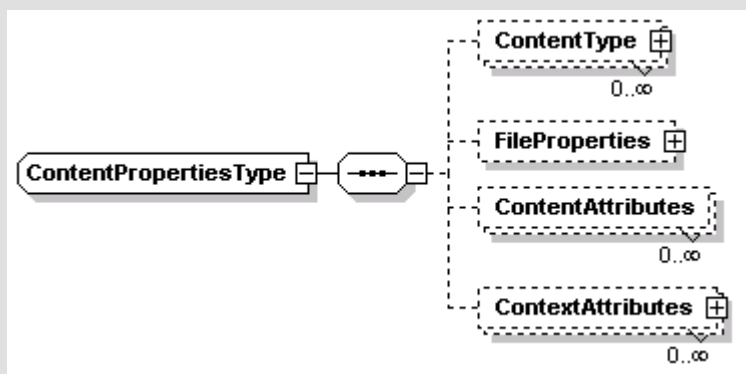

```

<complexType name="ContentPropertiesType">
  <sequence>
    <element name="ContentType" type="tva:ControlledTermType" minOccurs="0"
maxOccurs="unbounded"/>
    <element name="FileProperties" type="tva2:FilePropertiesType" minOccurs="0"/>
    <element name="ContentAttributes" type="tva2:ContentAttributesType" minOccurs="0"
maxOccurs="unbounded"/>
    <element name="ContextAttributes" type="tva2:ContextAttributesType" minOccurs="0"
maxOccurs="unbounded"/>
  </sequence>
</complexType>

```

Name	Definition
ChecksumType	The value of the checksum is specified using Base16 (hexBinary schema type).
algorithm	This mandatory attribute carries a reference to a controlled term from ChecksumAlgorithmCS containing a list of possible checksum computation methods.
FilePropertiesType	File attributes of the content.
FileFormat	Indicates the file format.
FileSize	Indicates the size, in bytes, of the file where the content instance is stored.
Checksum	Allows a metadata recipient party to verify that the correct media file has been acquired by comparing the locally computed checksum with the value stated in the metadata. Several checksum can be provided using different checksum computation methods.
ContentPropertiesType	A complex type to indicate content properties.
ContentType	Indicates content type such as still image, and game (see Content Type CS in clause A.17).
FileProperties	File attributes of the content.
ContentAttributes	Indicates attribute of content according to content type.
ContextAttributes	Indicates attributes of content according to environment and circumstances.

6.2 Targeting information

The present clause defines descriptions applicable to a typical consumer's environment including terminal characteristics, network characteristics and natural environment. Various targeting scenarios can be enabled by matching the provided usage environment and the targeting conditions of the content.

TV-Anytime's usage environment description is based on the "Usage Environment Tools" as specified in ISO/IEC 21000-7 [19], clause 6.

6.2.1 Biographic information

The following describes descriptive properties of consumer's biographic information.

```

<complexType name="AgeRangeType">
  <attribute name="min" type="byte" use="optional"/>
  <attribute name="max" type="byte" use="optional"/>
</complexType>

<complexType name="LanguageType">
  <simpleContent>
    <extension base="language">
      <attribute name="type" use="optional" default="mainSpoken">
        <simpleType>
          <restriction base="NMTOKEN">
            <enumeration value="mainSpoken"/>
            <enumeration value="secondarySpoken"/>
            <enumeration value="otherSpoken"/>
            <enumeration value="mainLiteral"/>
            <enumeration value="secondaryLiteral"/>
            <enumeration value="otherLiteral"/>
          </restriction>
        </simpleType>
      </attribute>
    </extension>
  </simpleContent>
</complexType>

```

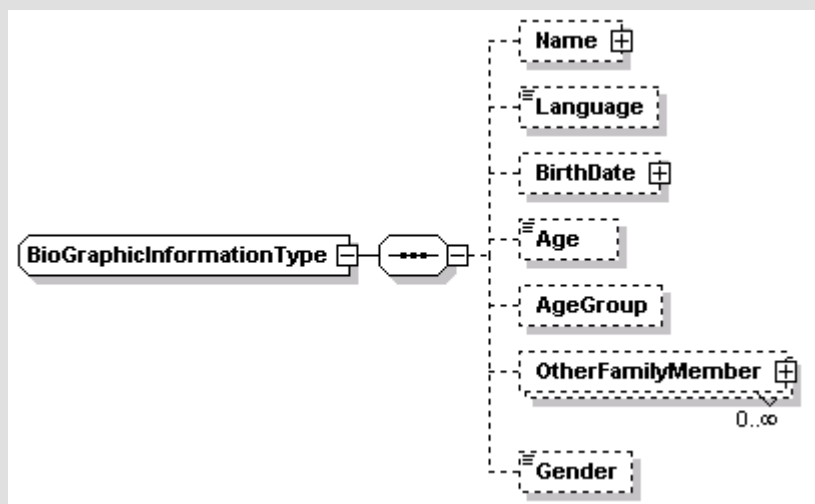

```

<complexType name="BiographicInformationType">
  <sequence>
    <element name="Name" type="mpeg7:PersonNameType" minOccurs="0"
      maxOccurs="unbounded"/>
    <element name="Language" type="tva2:LanguageType" minOccurs="0"
      maxOccurs="unbounded"/>
    <element name="BirthDate" type="mpeg7:TimeType" minOccurs="0"/>
    <element name="Age" type="mpeg7:unsigned8" minOccurs="0"/>
    <element name="AgeGroup" type="tva2:AgeRangeType" minOccurs="0"/>
    <element name="OtherFamilyMember" type="tva:ControlledTermType" minOccurs="0"
      maxOccurs="unbounded"/>
    <element name="Gender" minOccurs="0">
      <simpleType>
        <restriction base="NMTOKEN">
          <enumeration value="Male"/>
          <enumeration value="Female"/>
        </restriction>
      </simpleType>
    </element>
  </sequence>
</complexType>

```

Name	Definition
AgeRangeType	Describes the range that an age belongs.
min	Defines the lower bound of the age range.
max	Defines the upper bound of the age range.
BiographicInformationType	Defines consumer information in general, such as biographic information and special condition that the consumer might have.
Name	Describes the name of the consumer.
Language	Describes the language that the consumer uses. <ul style="list-style-type: none"> • mainSpoken: main spoken language of the consumer. • secondarySpoken: secondary spoken language of the consumer. • otherSpoken: other additional spoken language of the consumer. • mainLiteral: main language for reading/writing of the consumer. • secondaryLiteral: secondary language for reading/writing of the consumer. • otherLiteral: other additional language that the consumer can use for reading/writing.
Type	Defines the type used to describe the language. Default value is "mainSpoken".
BirthDate	Describes the date of birth of the consumer.
Age	Describes the age of the consumer.
AgeGroup	Describes the age of the consumer in terms of range.
OtherFamilyMember	Describes the family members of the consumer. See FamilyMembersCS in clause A.6.
Gender	Describes the gender of the consumer.

6.2.2 Accessibility information

If the consumer has special access condition needed to consume content, the following AccessibilityInformation table is to be used to describe such conditions.

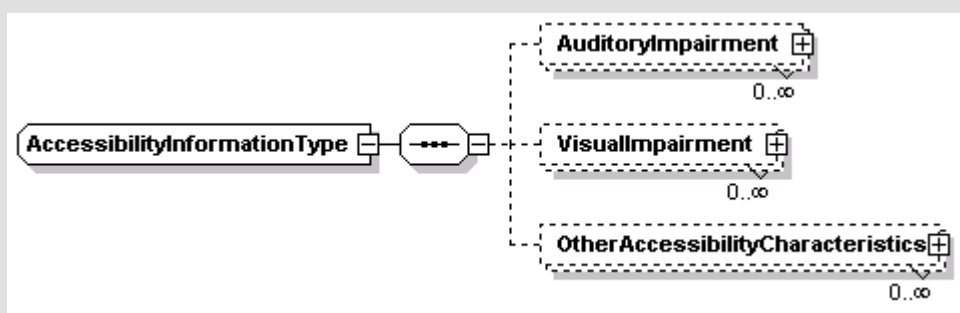

```

<complexType name="AccessibilityInformationType">
  <sequence>
    <element name="AuditoryImpairment" type="mpeg21:AuditoryImpairmentType" minOccurs="0"
maxOccurs="unbounded"/>
    <element name="VisualImpairment" type="mpeg21:VisualImpairmentType" minOccurs="0"
maxOccurs="unbounded"/>
    <element name="OtherAccessibilityCharacteristics" type="tva:ControlledTermType" minOccurs="0"
maxOccurs="unbounded"/>
  </sequence>
</complexType>
  
```

Name	Definition
AccessibilityInformationType	Defines special conditions of the consumer that might affect the consumption of the content.
AuditoryImpairment	Describes the impairment of a consumer's auditory system for the left and the right ear. See ISO/IEC 21000-7 [19] clause 6.4.15.3 for details.
VisualImpairment	Describes the impairment of a consumer's visual system. See ISO/IEC 21000-7 [19] clause 6.4.16.3 for details.
OtherAccessibilityCharacteristics	Describes other accessibility constraints of relevance to the targeting of content.

6.2.3 User information

The user information table holds multiples of user information and each user information describes information of a single consumer.

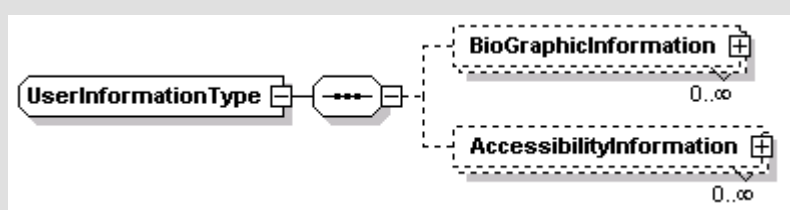

```

<complexType name="UserInformationType">
  <sequence>
    <element name="BiographicInformation" type="tva2:BiographicInformationType" minOccurs="0"
maxOccurs="unbounded"/>
    <element name="AccessibilityInformation" type="tva2:AccessibilityInformationType"
minOccurs="0" maxOccurs="unbounded"/>
  </sequence>
  <attribute name="userInformationId" type="tva:TVAIDType" use="optional" />
</complexType>
  
```

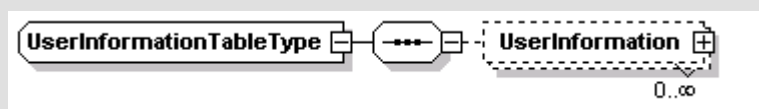

```

<complexType name="UserInformationTableType">
  <sequence>
    <element name="UserInformation" type="tva2:UserInformationType" minOccurs="0"
maxOccurs="unbounded"/>
  </sequence>
</complexType>
  
```

Name	Definition
UserInformationType	Defines biographic information and accessibility information of a single consumer. The link between consumer information and other user information can be provided at this level.
BiographicInformation	Describes biographic information of a consumer.
AccessibilityInformation	Describes the impairment of a consumer's visual and auditory system.
userInformationId	An attribute that uniquely identifies the user information.
UserInformationTableType	A placeholder for a list of user information.
UserInformation	A user information record.

6.2.4 Terminal information

The following describes descriptive properties of terminal information.

```

<simpleType name="VersionType">
  <restriction base="string">
    <whiteSpace value="collapse"/>
    <pattern value="[0-9]+(.[0-9]+) *"/>
  </restriction>
</simpleType>
<complexType name="VersionedControlledTermType">
  <complexContent>
    <extension base="tva:ControlledTermType">
      <sequence>
        <element name="Version" type="tva2:VersionType" minOccurs="0" maxOccurs="unbounded"/>
      </sequence>
    </extension>
  </complexContent>
</complexType>

<complexType name="CPUType">
  <complexContent>
    <extension base="tva:ControlledTermType">
      <attribute name="clockSpeed" type="nonNegativeInteger" use="required"/>
      <attribute name="unit" use="required">
        <simpleType>
          <restriction base="string">
            <enumeration value="Hz"/>
            <enumeration value="KHz"/>
            <enumeration value="MHz"/>
            <enumeration value="GHz"/>
            <enumeration value="THz"/>
            <enumeration value="PHz"/>
          </restriction>
        </simpleType>
      </attribute>
    </extension>
  </complexContent>
</complexType>

<complexType name="RAMType">
  <attribute name="size" type="nonNegativeInteger" use="required"/>
  <attribute name="unit" use="required">
    <simpleType>
      <restriction base="string">
        <enumeration value="Bit"/>
        <enumeration value="KBit"/>
        <enumeration value="MBit"/>
        <enumeration value="GBit"/>
        <enumeration value="Byte"/>
        <enumeration value="KByte"/>
        <enumeration value="MByte"/>
        <enumeration value="GByte"/>
        <enumeration value="TByte"/>
        <enumeration value="PByte"/>
      </restriction>
    </simpleType>
  </attribute>
</complexType>

```

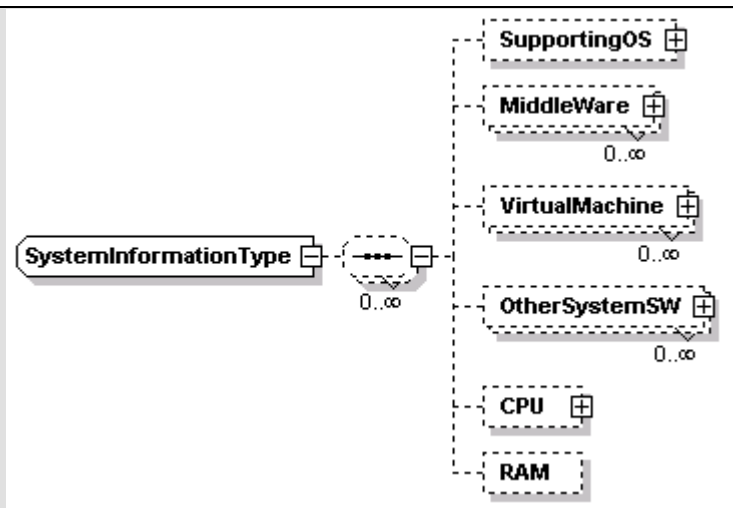

```

<complexType name="SystemInformationType">
  <sequence minOccurs="0" maxOccurs="unbounded">
    <element name="SupportingOS" type="tva2:VersionedControlledTermType" minOccurs="0"/>
    <element name="MiddleWare" type="tva2:VersionedControlledTermType" minOccurs="0"
      maxOccurs="unbounded"/>
    <element name="VirtualMachine" type="tva2:VersionedControlledTermType" minOccurs="0"
      maxOccurs="unbounded"/>
    <element name="OtherSystemSW" type="tva2:VersionedControlledTermType" minOccurs="0"
      maxOccurs="unbounded"/>
      <element name="CPU" type="tva2:CPUType" minOccurs="0"/>
      <element name="RAM" type="tva2:RAMType" minOccurs="0"/>
  </sequence>
</complexType>

```

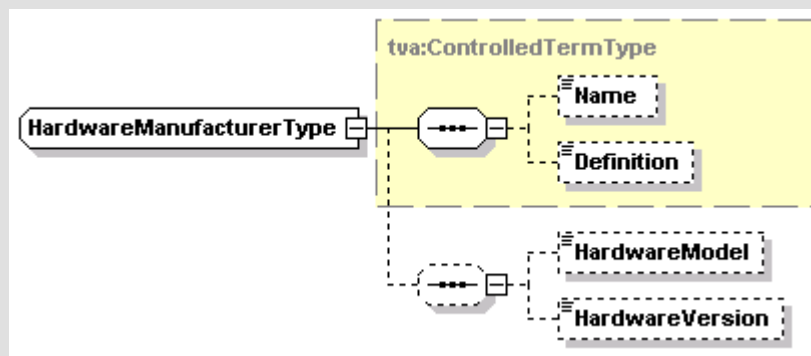

```

<complexType name="HardwareManufacturerType">
  <complexContent>
    <extension base="tva:ControlledTermType">
      <sequence minOccurs="0">
        <element name="HardwareModel" type="string" minOccurs="0"/>
        <element name="HardwareVersion" type="tva2:VersionType" minOccurs="0"/>
      </sequence>
    </extension>
  </complexContent>
</complexType>

```



```

<complexType name="TerminalInformationType">
  <sequence>
    <element name="DecoderInformation" type="mpeg21:CodecCapabilityBaseType"
      minOccurs="0" maxOccurs="unbounded"/>
    <element name="EncoderInformation" type="mpeg21:CodecCapabilityBaseType"
      minOccurs="0" maxOccurs="unbounded"/>
    <element name="DisplayInformation" type="mpeg21:DisplayType" minOccurs="0"
      maxOccurs="unbounded"/>
    <element name="AudioInformation" type="mpeg21:AudioOutputType" minOccurs="0"
      maxOccurs="unbounded"/>
    <element name="InteractionInputInformation" type="mpeg21:UserInteractionInputType"
      minOccurs="0" maxOccurs="unbounded"/>
    <element name="StorageInformation" type="mpeg21:StorageType" minOccurs="0"
      maxOccurs="unbounded"/>
    <element name="SystemInformation" type="tva2:SystemInformationType" minOccurs="0"/>
    <element name="HardwareManufacturer" type="tva2:HardwareManufacturerType"
      minOccurs="0"/>
    <element name="TerminalType" type="tva:ControlledTermType" minOccurs="0"/>
  </sequence>
  <attribute name="terminalInformationId" type="tva:TVAIDType" use="optional" />
</complexType>

```

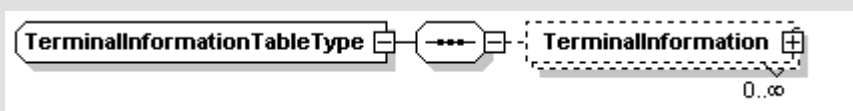

```

<complexType name="TerminalInformationTableType">
  <sequence>
    <element name="TerminalInformation" type="tva2:TerminalInformationType" minOccurs="0"
      maxOccurs="unbounded"/>
  </sequence>
</complexType>

```

Name	Definition
VersionType	A simple type that defines a version of the object.
VersionedControlledTermType	An extension of tva:ControlledtermType to express versions.
Version	An element to specify a version of the information expressed by the controlled term.
CPUType	A complex type that describes the properties of the processor.
clockSpeed	Describes the clock speed of the CPU.
unit	Defines the unit used to describe the CPU clock speed.
RAMType	A complex type that describes the properties of the Random Access Memory being used within the terminal.
size	Describes the size of the RAM.
unit	Defines the unit used to describe the RAM size.
SystemInformationType	A complex type that describe the properties of the terminal.
SupportingOS	Describes the operating system running in the terminal. See clause A.8 for a classification scheme of operating systems.
Version	A version of this operating system.
MiddleWare	Describes the middleware running in the terminal. See clause A.11 for a classification scheme of middleware.
Version	A version of the middleware.
VirtualMachine	Describes the virtual machines running in the terminal. See clause A.9 for a classification scheme of virtual machines.
Version	A version of the virtual machine.
OtherSystemSW	Describes system software running in the terminal other than middleware and virtual machines. See clause A.10 for a classification scheme of other system software.
Version	A version of this system software.
CPU	Describes the CPU of the terminal. See annex A for the classification scheme of the CPU names.
RAM	Describes the RAM of the terminal.
HardwareManufacturerType	A complex type that describes the properties of the hardware.
HardwareModel	Describes the terminal device model depending on a specific manufacturer.
HardwareVersion	Describes a version of embedded operating system in a terminal device.
TerminalInformationType	Describes the capability of a single terminal device.
DecoderInformation	Describes the decoding capability of the terminal. See ISO/IEC 21000-7 [19], clause 6.5.4.
EncoderInformation	Describes the encoding capability of the terminal. See ISO/IEC 21000-7 [19], clause 6.5.4.
DisplayInformation	Tool for describing the capability of displays. See ISO/IEC 21000-7 [19], clause 6.5.8.
AudioInformation	Describes the audio presentation capability of the terminal. See ISO/IEC 21000-7 [19], clause 6.5.12. Note that the audio capabilities regarding codec are described in DecoderInformation and/or EncoderInformation.
InteractionInputInformation	Describes the User interaction input support of the terminal. See ISO/IEC 21000-7 [19], clause 6.5.14.
StorageInformation	Describes the characteristics of the storage unit. See ISO/IEC 21000-7 [19], clause 6.5.18.
SystemInformation	Describes the system information of the terminal.
HardwareManufacturer	Indicates manufacturer of the hardware.
TerminalType	Describes the terminal type based on the types of device such as PC, PDA and so on. See clause A.12 for the classification scheme of the terminal types.

Name	Definition
terminalInformationId	An attribute that uniquely identifies the terminal information.
TerminalInformationTableType	A complex type that describes a table of the capability of terminal device.
TerminalInformation	A list of the capability of terminal information records for a single terminal.

6.2.5 Network information

The following describes descriptive properties of network information.

```

<complexType name="NetworkInformationType">
  <sequence>
    <element name="NetworkCharacteristic"
      type="mpeg21:NetworkCharacteristicBaseType" minOccurs="0" maxOccurs="unbounded"/>
  </sequence>
  <attribute name="networkInformationId" type="tva:TVAIDType" use="optional" />
</complexType>

```

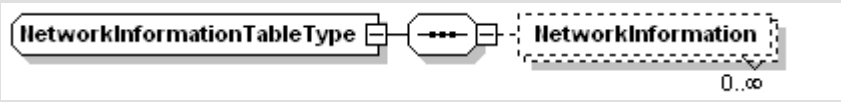

```

<complexType name="NetworkInformationTableType">
  <sequence>
    <element name="NetworkInformation" type="tva2:NetworkInformationType" minOccurs="0"
      maxOccurs="unbounded"/>
  </sequence>
</complexType>

```

Name	Definition
NetworkInformationType	A definition of NetworkInformation.
NetworkCharacteristic	An element to provide the definition of a subset of types defined as part of the NetworkType. See ISO/IEC 21000-7 [19], clause 6.6.4.
networkInformationId	An attribute that uniquely identifies the network information.
NetworkInformationTableType	Place holder to contain descriptions of the characteristics of a network connected to the TVA Box.
NetworkInformation	A place contains descriptions of a single network.

6.2.6 Natural environment information

The following describes descriptive properties of natural information.

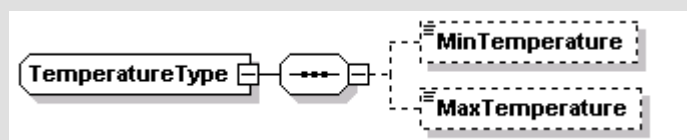

```
<complexType name="TemperatureType">
  <sequence>
    <element name="MinTemperature" type="float" minOccurs="0"/>
    <element name="MaxTemperature" type="float" minOccurs="0"/>
  </sequence>
  <attribute name="unit" use="required">
    <simpleType>
      <restriction base="string">
        <enumeration value="Celsius"/>
        <enumeration value="Fahrenheit"/>
      </restriction>
    </simpleType>
  </attribute>
</complexType>
```

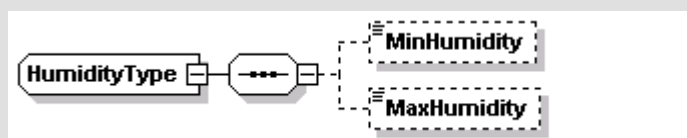

```
<complexType name="HumidityType">
  <sequence>
    <element name="MinHumidity" type="float" minOccurs="0"/>
    <element name="MaxHumidity" type="float" minOccurs="0"/>
  </sequence>
  <attribute name="type" use="required">
    <simpleType>
      <restriction base="string">
        <enumeration value="Absolute"/>
        <enumeration value="Relative"/>
      </restriction>
    </simpleType>
  </attribute>
</complexType>
```

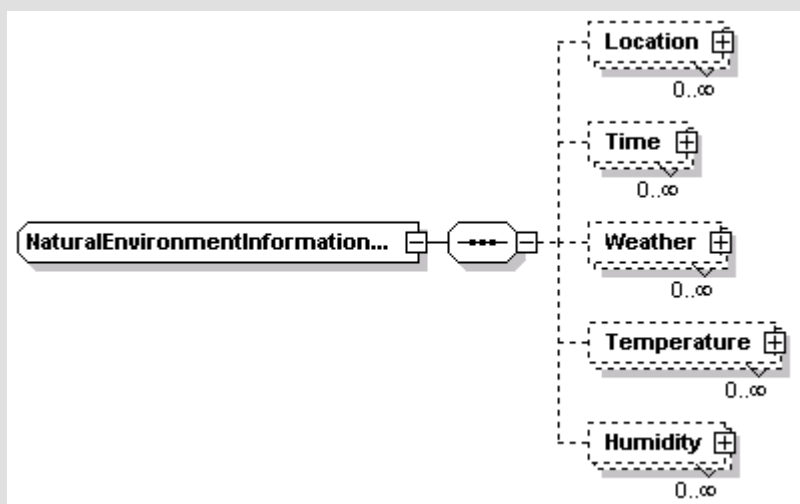

```
<complexType name="NaturalEnvironmentInformationType">
  <sequence>
    <element name="Location" type="mpeg7:PlaceType" minOccurs="0"
      maxOccurs="unbounded"/>
    <element name="Time" type="mpeg7:TimeType" minOccurs="0" maxOccurs="unbounded"/>
    <element name="Weather" type="tva:ControlledTermType" minOccurs="0"
      maxOccurs="unbounded"/>
    <element name="Temperature" type="tva2:TemperatureType" minOccurs="0"
      maxOccurs="unbounded"/>
    <element name="Humidity" type="tva2:HumidityType" minOccurs="0"
      maxOccurs="unbounded"/>
  </sequence>
</complexType>
```

```

maxOccurs="unbounded"/>
<element name="Humidity" type="tva2:HumidityType" minOccurs="0"
maxOccurs="unbounded"/>
</sequence>
<attribute name="naturalEnvironmentInformationId" type="tva:TVAIDType"
use="optional"/>
</complexType>

```

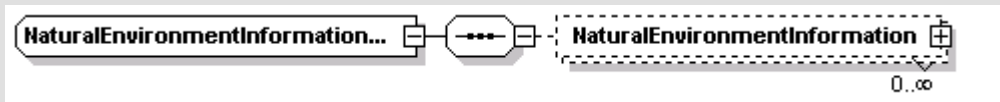

```

<complexType name="NaturalEnvironmentInformationTableType">
<sequence>
<element name="NaturalEnvironmentInformation"
type="tva2:NaturalEnvironmentInformationType" minOccurs="0"
maxOccurs="unbounded"/>
</sequence>
</complexType>

```

Name	Definition
TemperatureType	A complex type that describes the temperature.
MinTemperature	Describes the lower bound of the temperature.
MaxTemperature	Describes the upper bound of the temperature.
unit	Defines the unit of the temperature. One of Celsius or Fahrenheit.
HumidityType	A complex type that describes the humidity.
MinHumidity	Describes the lower bound of the humidity.
MaxHumidity	Describes the upper bound of the humidity.
type	Defines the type used to describe the humidity. Either absolute or relative.
NaturalEnvironmentInformationType	Describes the present natural environment of the content consumption.
Location	Describes the physical location of the content consumption.
Time	Describes the present time.
Weather	Describes the weather of the given time and location.
Temperature	Describes the temperature of the user environment.
Humidity	Describes the humidity of the user environment.
naturalEnvironmentInformationId	An attribute that uniquely identifies the natural environment information.
NaturalEnvironmentInformationTableType	A complex type that describes a table of natural environment of the content consumption.
NaturalEnvironmentInformation	A list of natural environment description records.

6.2.7 Usage environment description table

The following describes descriptive properties of usage environment.

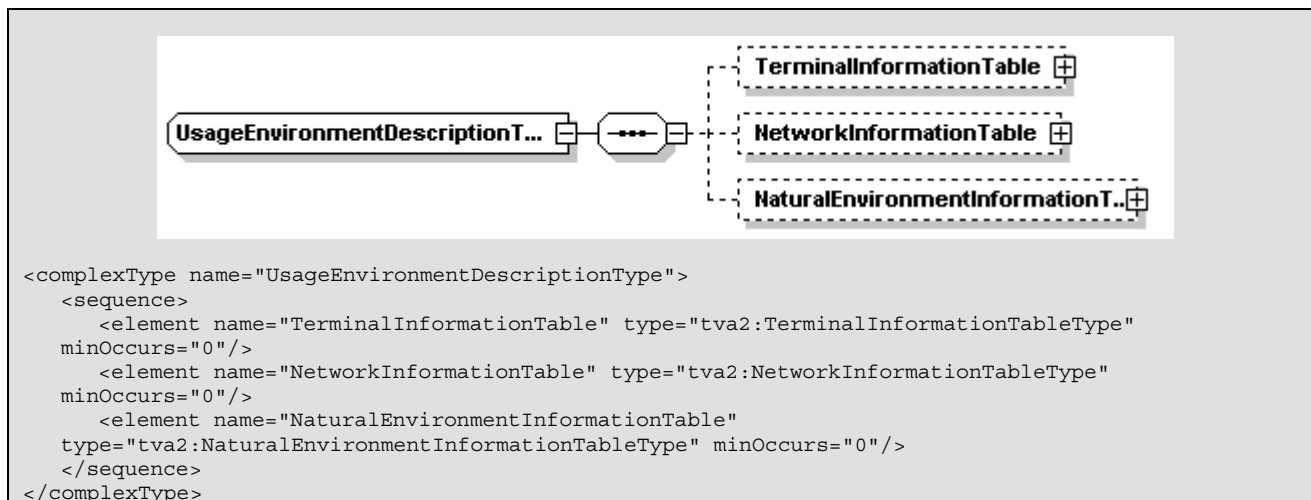

Name	Definition
UsageEnvironmentDescriptionType	Defines description of the environment of content consumption.
TerminalInformationTable	The terminal information table.
NetworkInformationTable	The network information table.
NaturalEnvironmentInformationTable	The natural environment information table.

6.2.8 TargetingInformationType

The following describes information on targeted user(s) based on user preferences, usage history, device(s), and network capabilities.

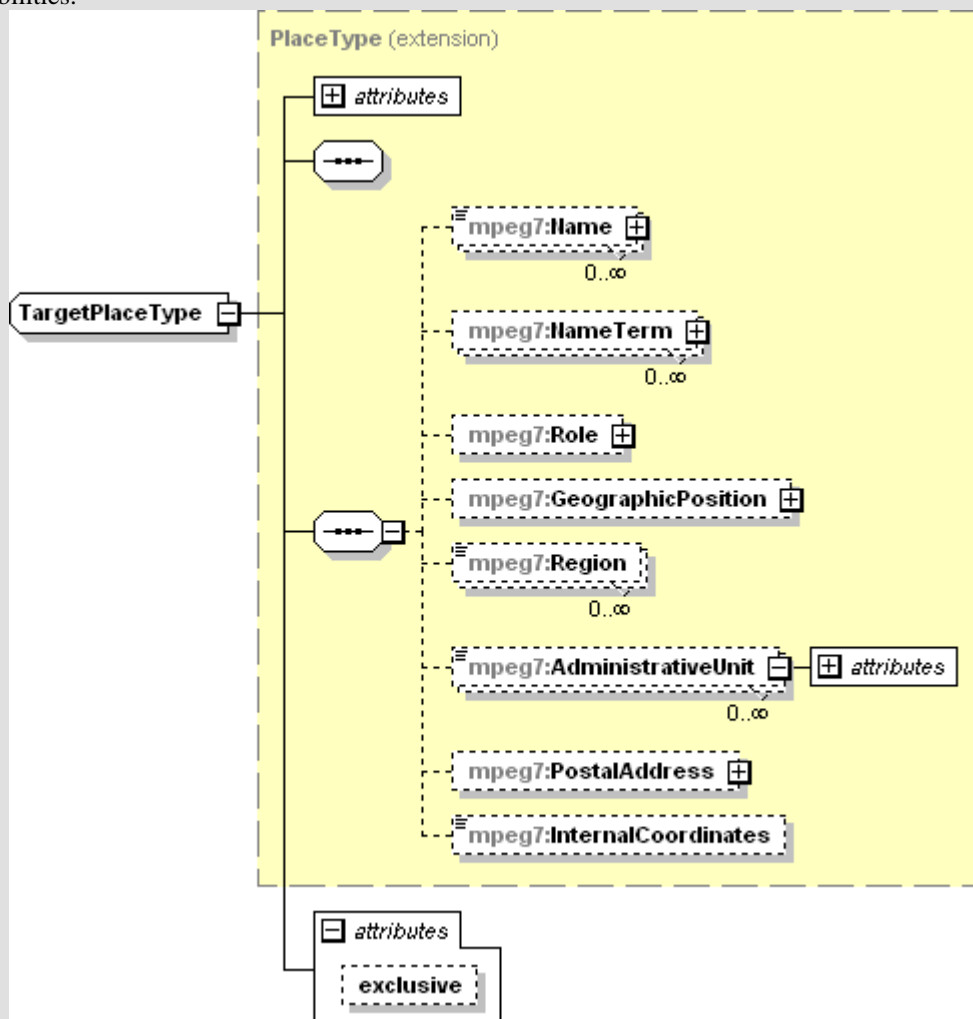

```
<complexType name="TargetPlaceType">
  <complexContent>
    <extension base="mpeg7:PlaceType">
      <attribute name="exclusive" type="boolean" use="optional" default="false"/>
    </extension>
  </complexContent>
</complexType>
```

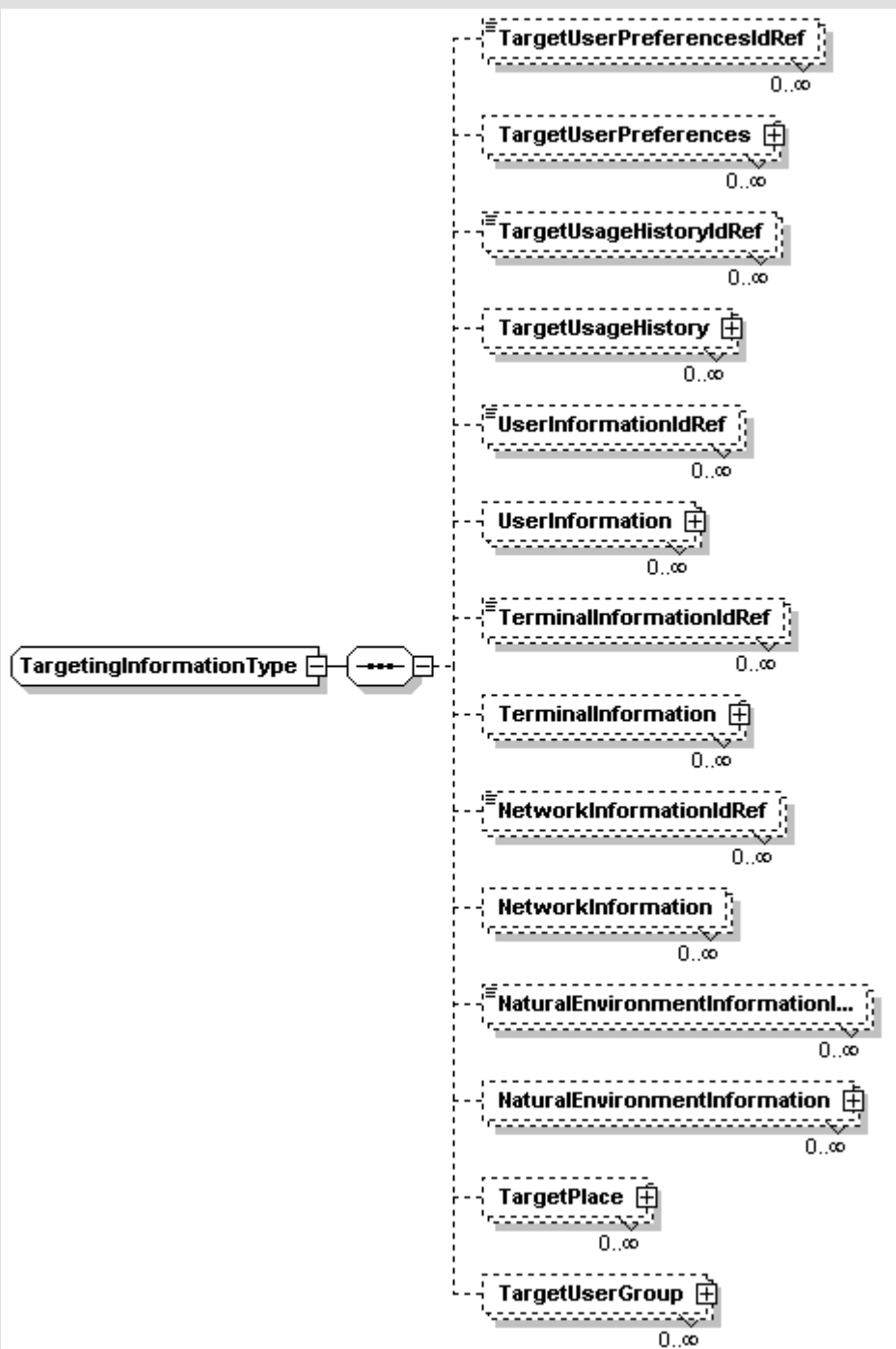

```

<complexType name="TargetingInformationType">
  <sequence>
    <element name="TargetUserPreferencesIdRef" type="tva:TVAIDRefType" minOccurs="0"
      maxOccurs="unbounded"/>
    <element name="TargetUserPreferences" type="mpeg7:UserPreferencesType"
      minOccurs="0" maxOccurs="unbounded"/>
    <element name="TargetUsageHistoryIdRef" type="tva:TVAIDRefType" minOccurs="0"
      maxOccurs="unbounded"/>
    <element name="TargetUsageHistory" type="mpeg7:UsageHistoryType" minOccurs="0"
      maxOccurs="unbounded"/>
    <element name="UserInformationIdRef" type="tva:TVAIDRefType" minOccurs="0"
      maxOccurs="unbounded"/>
    <element name="UserInformation" type="tva2:UserInformationType" minOccurs="0"
      maxOccurs="unbounded"/>
    <element name="TerminalInformationIdRef" type="tva:TVAIDRefType" minOccurs="0"
      maxOccurs="unbounded"/>
    <element name="TerminalInformation" type="tva2:TerminalInformationType"
  
```

```

    minOccurs="0" maxOccurs="unbounded"/>
  <element name="NetworkInformationIdRef" type="tva:TVAIDRefType" minOccurs="0"
maxOccurs="unbounded"/>
  <element name="NetworkInformation" type="mpeg21:NetworkCharacteristicBaseType"
minOccurs="0" maxOccurs="unbounded"/>
  <element name="NaturalEnvironmentInformationIdRef" type="tva:TVAIDRefType"
minOccurs="0" maxOccurs="unbounded"/>
  <element name="NaturalEnvironmentInformation"
type="tva2:NaturalEnvironmentInformationType"
minOccurs="0" maxOccurs="unbounded"/>
  <element name="TargetPlace" type="tva2:TargetPlaceType" minOccurs="0" maxOccurs="unbounded"/>
  <element name="TargetUserGroup" type="tva:ControlledTermType" minOccurs="0"
maxOccurs="unbounded"/>
</sequence>
<attribute name="targetingId" type="tva:TVAIDType" use="optional" />
</complexType>

```

Name	Definition
TargetPlace	A type providing information about a geographical place. Based on the MPEG-7 datatype <code>PlaceType</code> (see clause 5.6.4 of ISO/IEC 15938-5 [16] for a detailed specification).
exclusive	A Boolean attribute indicating whether the targeting is exclusive to this place (true), or is only suggestive of greater interest or relevance of the content to this place (false).
TargetingInformationType	Information that describes the targeted User, and device, network capabilities.
TargetUserPreferencesIDRef	A reference to a globally declared set of user preference information contained within the <code>TargetingInformationTable</code> .
TargeUserPreferences	Information about user preferences.
TargetUsageHistoryIDRef	A reference to a globally declared set of user usage history information contained within the <code>TargetingInformationTable</code> .
TargetUsageHistory	Information about usage history.
UserInformationIDRef	A reference to a globally declared set of User Information, contained within the <code>TargetingInformationTable</code> .
UserInformation	Information about the targeted User.
TerminalInformationIDRef	A reference to a globally declared set of Terminal Information, contained within the <code>TargetingInformationTable</code> .
TerminalInformation	Information about the required terminal capabilities.
NetworkInformationIDRef	A reference to a globally declared set of Network Information, contained within the <code>TargetingInformationTable</code> .
NetworkInformation	Information about the required Network capabilities.
NaturalEnvironmentInformationIDRef	A reference to a globally declared set of Natural Environment Information, contained within the <code>TargetingInformationTable</code> .
NaturalEnvironmentInformation	Information about the targeted Natural Environment.
TargetPlace	Information about the targeted geographical place.
TargetUserGroup	Information about the targeted user group, expressed as a term from a Classification Scheme.
targetingId	A unique identifier for the Targeting Information.

6.3 Coupon description

A coupon description allows you to describe pricing and discount information for a content item.

```

<complexType name="NonTVACouponRefType">
  <simpleContent>
    <extension base="anyURI">
      <attribute name="couponAuthority" type="string" use="required"/>
    </extension>
  </simpleContent>
</complexType>

<complexType name="RequiredCouponType">
  <attribute name="couponId" type="tva:TVAIDType" use="required"/>
  <attribute name="authorityName" type="anyURI" use="optional"/>
  <attribute name="requiredNumber" type="positiveInteger" use="optional"/>
</complexType>

```

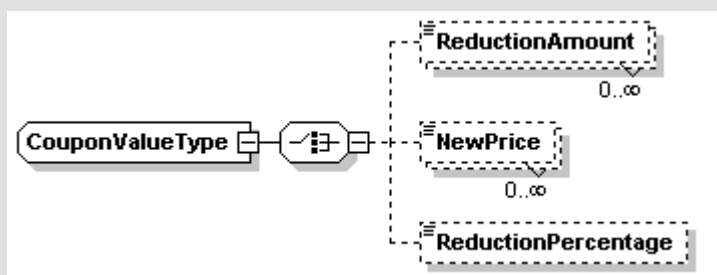

```

<complexType name="CouponValueType">
  <choice>
    <element name="ReductionAmount" type="tva:PriceType" minOccurs="0"
      maxOccurs="unbounded"/>
    <element name="NewPrice" type="tva:PriceType" minOccurs="0"
      maxOccurs="unbounded"/>
    <element name="ReductionPercentage" type="integer" minOccurs="0"/>
  </choice>
  <attribute name="purchaseIdRef" type="tva:TVAIDRefType" use="optional"/>
</complexType>

```

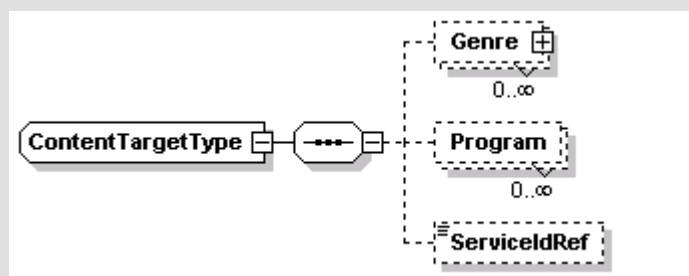

```

<complexType name="ContentTargetType">
  <sequence>
    <element name="Genre" type="tva:GenreType" minOccurs="0"
      maxOccurs="unbounded"/>
    <element name="Program" type="tva:CRIDRefType" minOccurs="0"
      maxOccurs="unbounded"/>
    <element name="ServiceIdRef" type="tva:TVAIDRefsType" minOccurs="0"
      maxOccurs="1"/>
  </sequence>
</complexType>

```

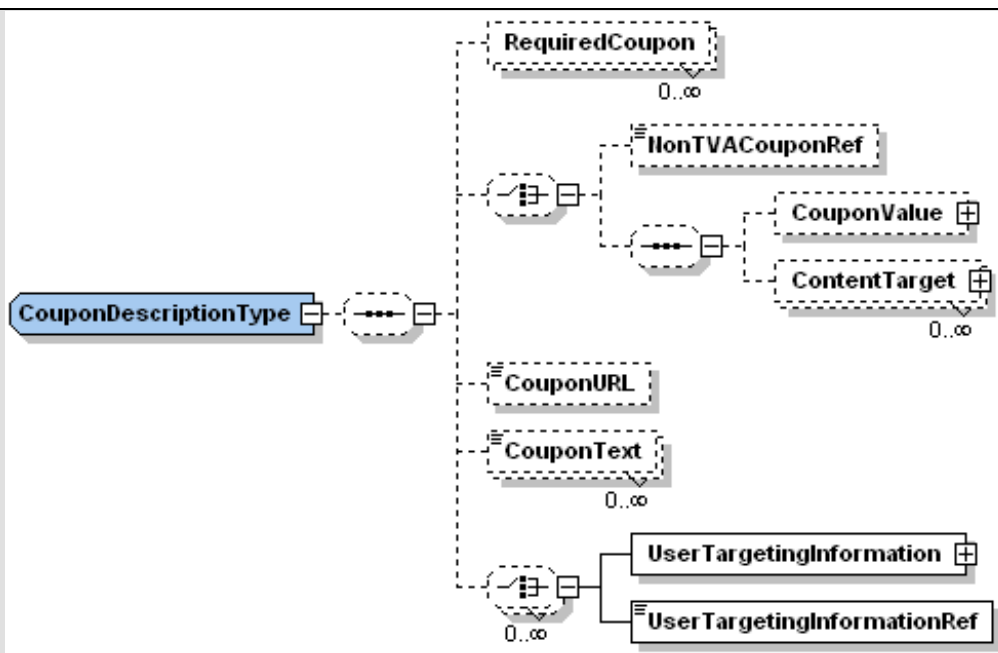

```

<complexType name="CouponDescriptionType">
  <sequence minOccurs="0">
    <element name="RequiredCoupon" type="tva2:RequiredCouponType" minOccurs="0"
maxOccurs="unbounded"/>
    <choice minOccurs="0">
      <element name="NonTVACouponRef" type="tva2:NonTVACouponRefType"
minOccurs="0"/>
      <sequence minOccurs="0">
        <element name="CouponValue" type="tva2:CouponValueType"/>
        <element name="ContentTarget" type="tva2:ContentTargetType" minOccurs="0"
maxOccurs="unbounded"/>
      </sequence>
    </choice>
    <element name="CouponURL" type="anyURI" minOccurs="0"/>
    <element name="CouponText" type="mpeg7:TextualType" minOccurs="0"
maxOccurs="unbounded"/>
    <choice minOccurs="0" maxOccurs="unbounded">
      <element name="UserTargetingInformation"
type="tva2:TargetingInformationType"/>
      <element name="UserTargetingInformationRef" type="tva:TVAIDRefType"/>
    </choice>
  </sequence>
  <attribute name="couponId" type="tva:TVAIDType"/>
  <attribute name="authorityName" type="anyURI" use="optional"/>
  <attribute name="requiredNumber" type="positiveInteger" use="optional"/>
  <attribute name="start" type="dateTime" use="optional"/>
  <attribute name="end" type="dateTime" use="optional"/>
  <attribute name="acquisitionMode" use="optional">
    <simpleType>
      <restriction base="string">
        <enumeration value="immediate"/>
        <enumeration value="linkedToContent"/>
      </restriction>
    </simpleType>
  </attribute>
</complexType>

```

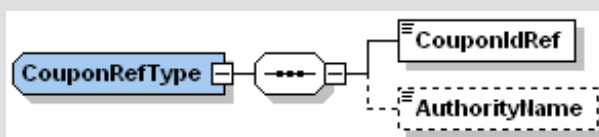

```

<complexType name="CouponRefType">
  <sequence>
    <element name="CouponIdRef" type="tva:TVAIDRefType"/>
    <element name="AuthorityName" type="anyURI" minOccurs="0"/>
  </sequence>
</complexType>

```

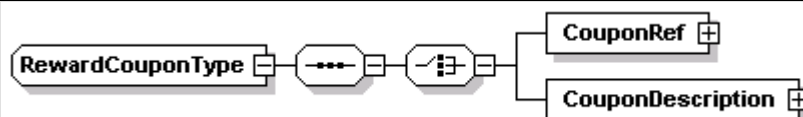
```

<complexType name="RewardCouponType">
  <sequence>
    <choice>
      <element name="CouponRef" type="tva2:CouponRefType"/>
      <element name="CouponDescription" type="tva2:CouponDescriptionType"/>
    </choice>
  </sequence>
  <attribute name="userConfirmationRequired" type="boolean" use="optional"
  default="false"/>
  <attribute name="number" type="positiveInteger" use="optional" default="1"/>
</complexType>
  
```

Name	Definition
NonTVACouponRefType	A complex type to indicate a reference to a coupon delivered by an authority for products or services outside the TVA context.
couponAuthority	An attribute to indicate an authority for products or services outside the TVA context.
RequiredCouponType	A complex type to identify the coupon.
couponId	This mandatory attribute identifies the coupon within a specific authority and allows to refer to it from a "PurchaseItem" or from "RewardCoupon" in a "PurchaseItem".
authorityName	This optional attribute contains the identity of the authority responsible for this coupon. The authorityName has to be a registered Internet domain name (similar to CRID Authority).
requiredNumber	This optional attribute indicates the number of copies of the required coupon the client has to acquire. For example, this can be used to express that 2 coupons A and 3 coupons B give the user a better price for a specific content. The default value is "1".
CouponValueType	A complex type to define the value of the coupon in terms of reduction amount, new content price or reduction percentage.
ReductionAmount	This optional element is used to express the reduction amount to be applied to the price available in the "PurchaseItem".
NewPrice	This optional element is used to express the new price of the targeted content.
ReductionPercentage	This optional element is used to express the reduction percentage to be applied to the price available in the "PurchaseItem".
purchaseIdRef	When there are several "PurchaseItem" included in a basic description, this optional attribute allows to refer to a specific one. If this attribute is not present, this coupon applies to the "main" "PurchaseItem" of the "PurchaseList".
ContentTargetType	A complex type to indicate the contents for which the coupon can be used.
Genre	This optional element is used to specify the genre of the contents to which this coupon applies.
Program	This optional element is used to specify a program to which this coupon applies.
ServiceIdRef	This optional element is used to specify specific channel(s) to be discounted.
CouponDescriptionType	This element contains the coupon description.

Name	Definition
RequiredCoupon	This optional element signals a coupon that shall be held before this offer is valid. In the case where there are multiple instances of RequiredCoupon then all shall be held before the offer is valid. If this element is present, there are at least two "RequiredCoupons".
NonTVACouponRef	This optional element contains a reference to a coupon delivered by an authority for products or services outside the TVA context.
CouponValue	This mandatory element is used to express the value of the coupon in terms of reduction amount, new content price or reduction percentage.
ContentTarget	This optional element is used to identify the contents for which the coupon can be used.
CouponURL	This optional element contains a server address. It can be used by the client to inquire about acquired coupons. It can also be used to synchronize the coupon situation of the STB by implementation specific protocols.
CouponText	This optional element allows to provide a description of the coupon to be displayed to the user.
UserTargetingInformation	This optional element allows to specify a type of user and/or device for which this coupon is valid.
UserTargetingInformationRef	A reference to a globally declared set of Targeting Information, contained within the TargetingInformationTable.
couponId	This mandatory attribute identifies the coupon within a specific authority and allows to refer to it from a "PurchaseItem" or from "RewardCoupon" in a "PurchaseItem".
authorityName	This optional attribute contains the identity of the authority responsible for this coupon. The authorityName has to be a registered Internet domain name (similar to CRID Authority).
requiredNumber	This optional attribute indicates the number of copies of this coupon the client has to acquire to be able to use it. For example, each movie purchase gives a coupon A and three such coupons A give the right to get a fourth movie at a discounted price. The default value is "1".
start	This optional attribute indicates the start date and time of the coupon validity period. The default value means "validity period has already started".
end	This optional attribute indicates the end date and time of the coupon validity period. The default value means "validity is permanent".
acquisitionMode	This optional attribute states that this coupon is acquired at the reception of its description (value = "immediate") or acquired with the purchase/acquisition/viewing of some content (value = "linkedToContent"). The default value is "linkedToContent".
CouponRefType	A complex type that defines a reference to a coupon.
CouponIdRef	A reference to a globally declared coupon, contained within the CouponTable.
AuthorityName	This optional element contains the identity of the authority responsible for this coupon.

Name	Definition
RewardCouponType	A complex type that defines the coupon to be delivered as a reward on this content acquisition.
CouponRef	This optional element identifies a reward coupon.
CouponDescription	This optional element contains the description of the reward coupon.
userConfirmationRequired	This optional attribute indicates that the PDR has to request the user confirmation to get the coupon. If the user does not accept the coupon, it will not be kept by the STB. Default value is "false".
number	This optional attribute indicates the number of reward coupons. Default value is "1".

6.4 Extended purchase item description

The following allows instantiation of rights information and coupon information with a purchase item.

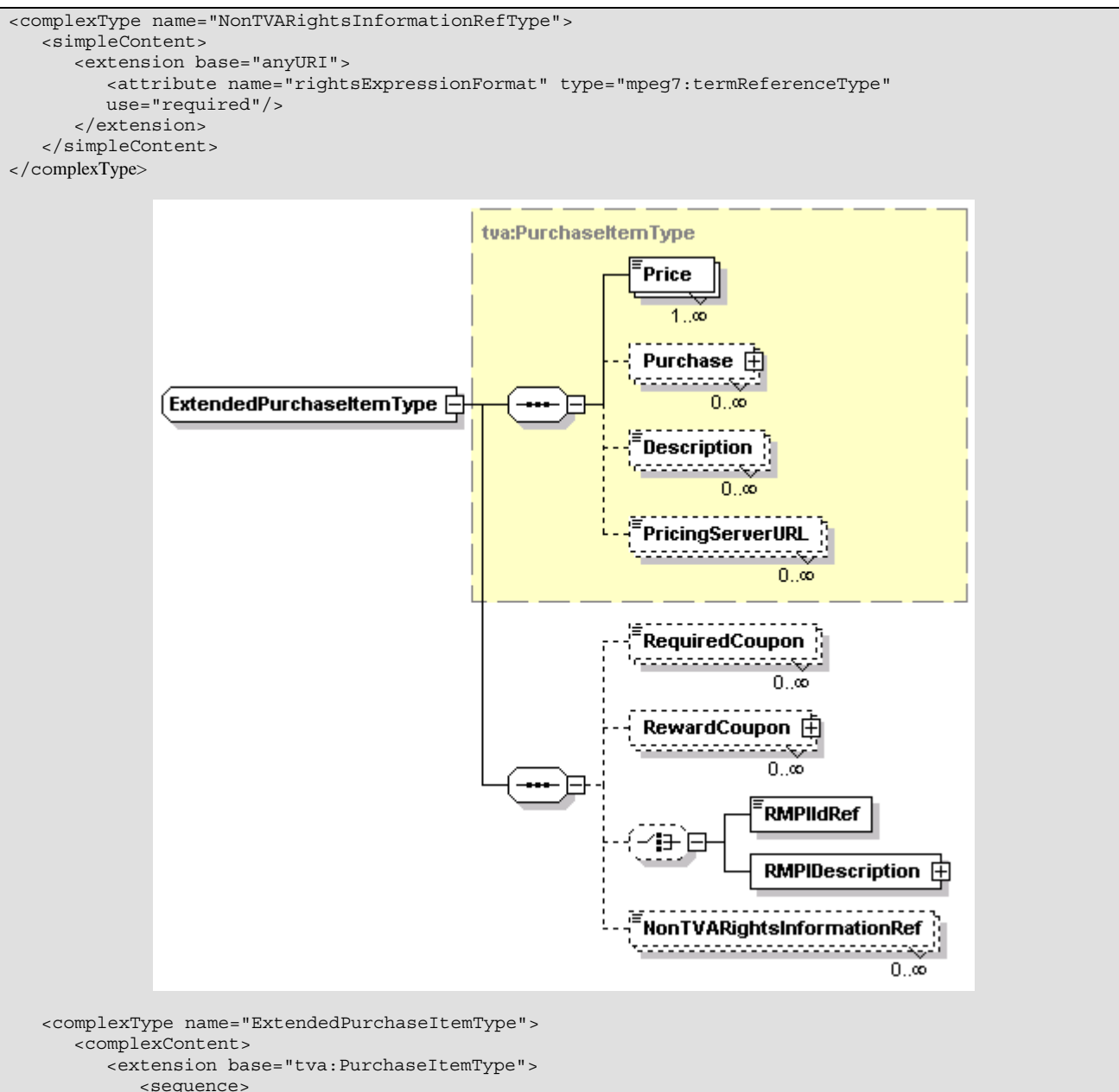

```

<element name="RequiredCoupon" type="tva2:RequiredCouponType" minOccurs="0"
maxOccurs="unbounded"/>
<element name="RewardCoupon" type="tva2:RewardCouponType" minOccurs="0"
maxOccurs="unbounded"/>
<choice minOccurs="0">
  <element name="RMPIIDRef" type="tva:TVAIDRefType"/>
  <element name="RMPIDescription" type="tva2:RMPIDescriptionType"/>
</choice>
<element name="NonTVARightsInformationRef"
type="tva2:NonTVARightsInformationRefType" minOccurs="0" maxOccurs="unbounded"/>
</sequence>
<attribute name="type" use="optional" default="main">
  <simpleType>
    <restriction base="string">
      <enumeration value="main"/>
      <enumeration value="other"/>
    </restriction>
  </simpleType>
</attribute>
</extension>
</complexContent>
</complexType>

```

Name	Definition
NonTVARightsInformationRefType	A complex type that is used to point to an external resource containing rights information expressed in a non-TVA-compliant format.
rightsExpressionFormat	This attribute is used to indicate the format of the rights information.
ExtendedPurchaseItemType	A complex type that defines the description of the "purchaseItem" extended with rights and coupon information.
RequiredCoupon	This element identifies one of the coupons if several, which is necessary to acquire the content at the conditions of this purchaseItem.
RewardCoupon	This element contains the description of a coupon to be delivered as a reward on this content acquisition.
RMPIIDRef	This element is used to refer to an instance of RMPIDescription in the RMPITable.
RMPIDescription	This element is used for direct incorporation of TVA-compliant RMPI information.
NonTVARightsInformationRef	This element is used to point to an external resource containing rights information expressed in a non-TVA-compliant format.
type	This optional attribute identifies the type of "purchaseItem", the value "main" is for the official or public price. The other value is "other". Only one "purchaseItem" in a purchaseList can have a type with the value "main". The default value is "main".

7 Extensions to programme description datatypes

7.1 Extended basic content description datatype

In the present document, the Phase 1 BasicContentDescriptionType has been extended to enable the description of new content types, content packages, content targeting and the association of printable material with content.

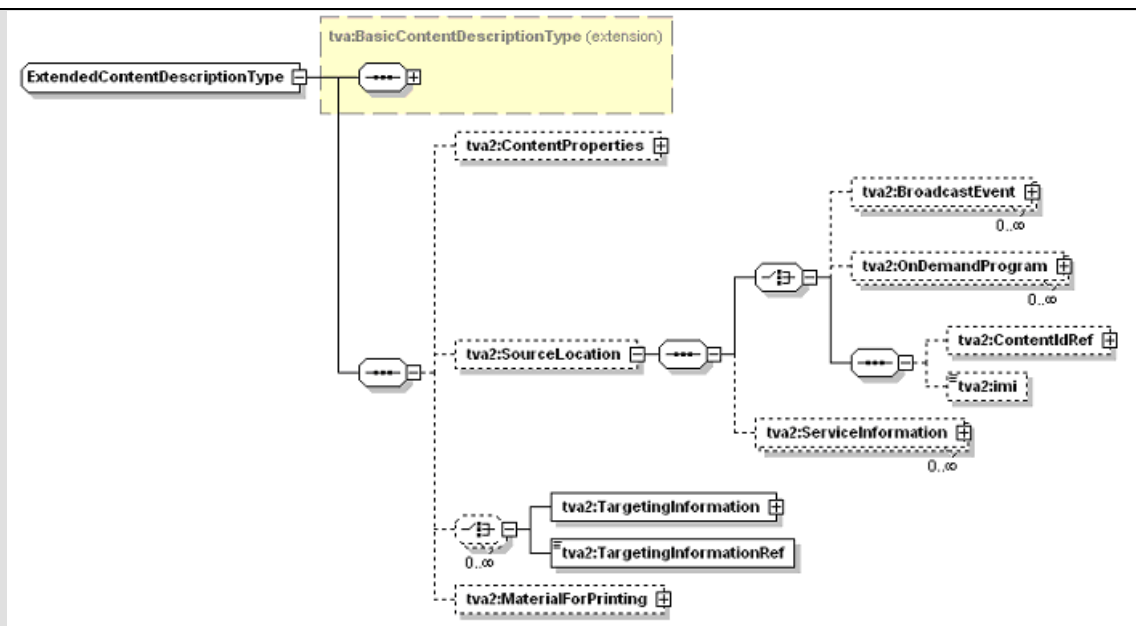

```

<complexType name="ExtendedContentDescriptionType">
  <complexContent>
    <extension base="tva:BasicContentDescriptionType">
      <sequence>
        <element name="ContentProperties" type="tva:ContentPropertiesType"
          minOccurs="0"/>
        <element name="SourceLocation" minOccurs="0">
          <complexType>
            <sequence>
              <choice>
                <element name="BroadcastEvent" type="tva:BroadcastEventType"
                  minOccurs="0" maxOccurs="unbounded"/>
                <element name="OnDemandProgram" type="tva:OnDemandProgramType"
                  minOccurs="0" maxOccurs="unbounded"/>
                <sequence>
                  <element name="ContentIdRef" type="tva:CRIDRefType"
                    minOccurs="0"/>
                  <element name="imi"
                    type="tva2:InstanceMetadataIdListType" minOccurs="0"/>
                </sequence>
              </choice>
              <element name="ServiceInformation" type="tva:ServiceInformationType"
                minOccurs="0" maxOccurs="unbounded"/>
            </sequence>
          </complexType>
        </element>
        <choice minOccurs="0" maxOccurs="unbounded">
          <element name="TargetingInformation" type="tva2:TargetingInformationType" />
          <element name="TargetingInformationRef" type="tva:TVAIDRefType" />
        </choice>
        <element name="MaterialForPrinting" minOccurs="0">
          <complexType>
            <sequence>
              <any namespace="##any" processContents="lax" minOccurs="0"/>
            </sequence>
          </complexType>
        </element>
      </sequence>
    </extension>
  </complexContent>
</complexType>

```

Name	Definition
ExtendedContentDescriptionType	A complex type that extends BasicContentDescriptionType to support non AV content types (e.g. still image, game, application).
ContentProperties	Information describing the type of content, its physical properties and intended use.
TargetingInformation	Information about the target user group and required usage environment for the content.
TargetingInformationRef	A reference to a globally declared set of targeting information, contained within the TargetingInformationTable.
MaterialForPrinting	Indicates whether content is used as material for printing. Material can be main-picture, template, clip-art, text, etc.
##any	Descriptive information for each material type that is imported from other namespace standardized by other national body.

NOTE: It is recommended to instantiate ExtendedContentDescription with all the conditions necessary to activate or consume the package, so that the user or client system does not have to download the package and to find out that it is not playable.

7.2 Extended instance description

The Phase 1 InstanceDescriptionType is here extended to enable the association of new content properties with individual content instances.

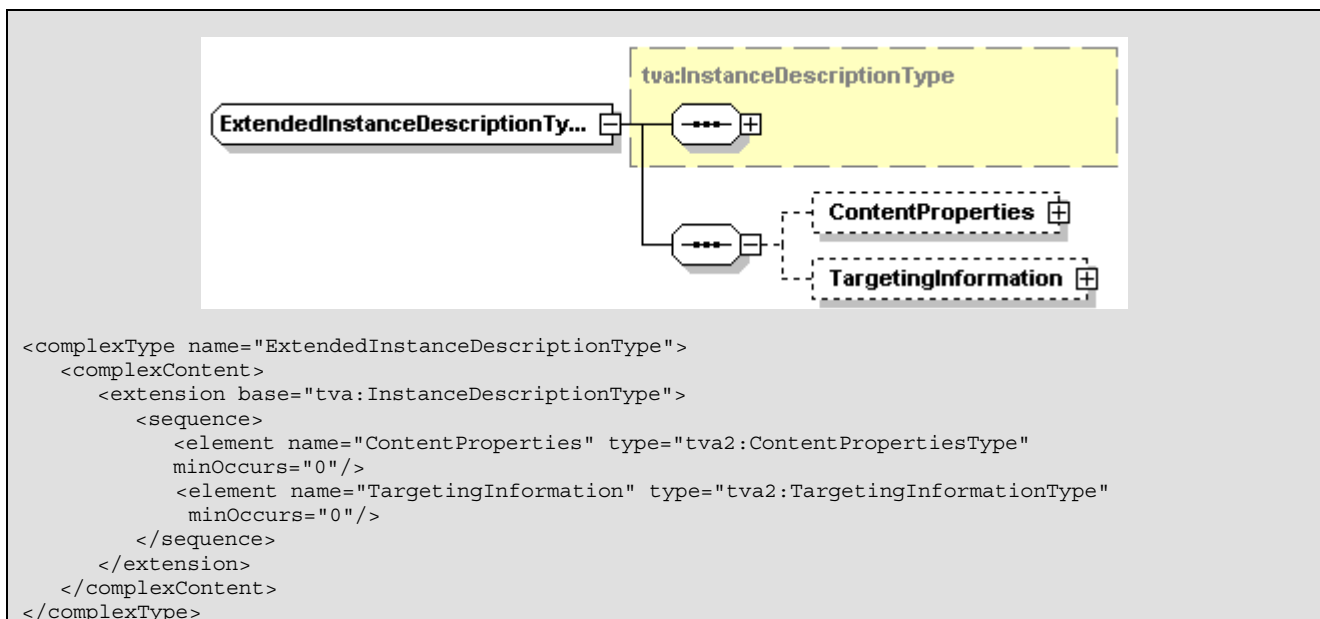

Name	Definition
ExtendedInstanceDescriptionType	A complex type that extends the phase 1 InstanceDescriptionType.
ContentProperties	Information describing the type of content, its physical properties and intended use.
TargetInformation	Information about the target user group and required usage environment for the instance.

7.3 Extended segment description

The ExtendedSegmentDescriptionType enables content providers and others to provide content consumers with coupons as a reward for consuming a content segment.

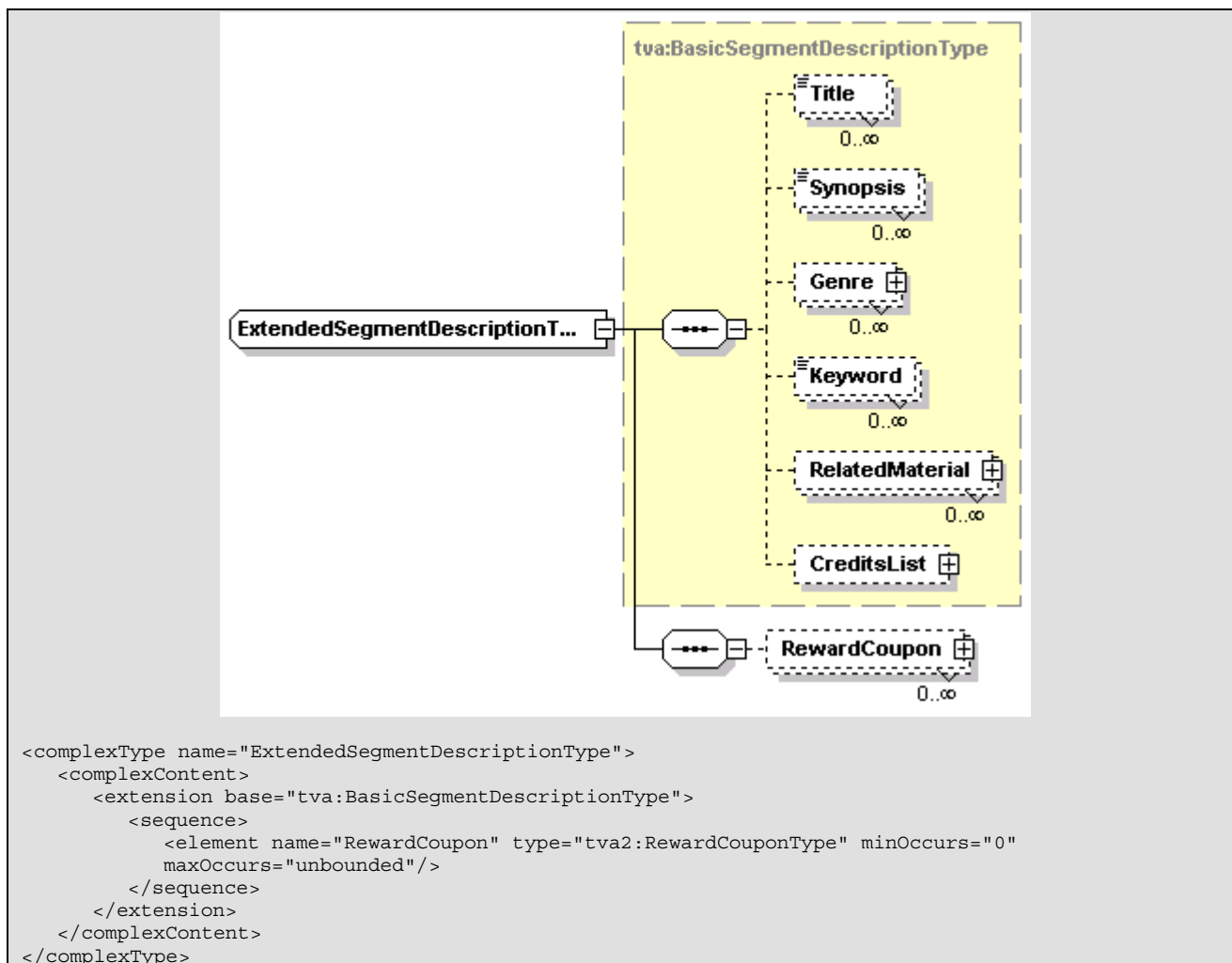

Name	Definition
ExtendedSegmentDescriptionType	A complex type that extends the Phase 1 BasicSegmentDescriptionType.
RewardCoupon	This element contains the description of the coupon to be delivered as a reward for the acquisition of the current segment.

7.4 Extended related material type

The ExtendedRelatedMaterialType enables content providers to declare the properties of related content that is referenced by the metadata description but not directly described by it.

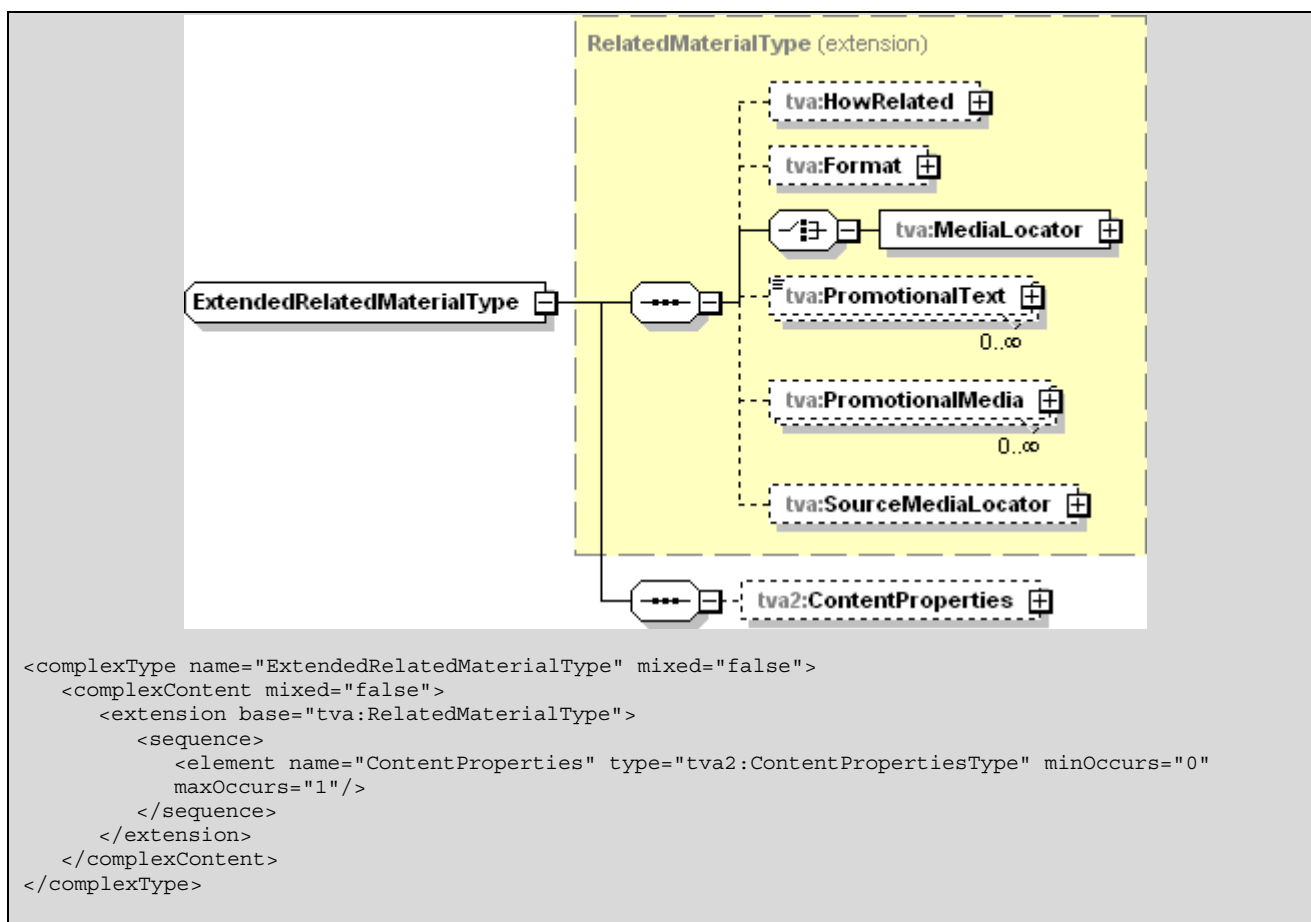

Name	Definition
ExtendedrelatedMaterialType	A complex type that extends the phase 1 RelatedMaterialType.
ContentProperties	This element provides properties of content otherwise not identified by a CRID through which descriptive information to be linked.

7.5 Extended service information type

The Phase 1 `ServiceInformationType` is here extended to enable the association of targeting metadata with individual services.

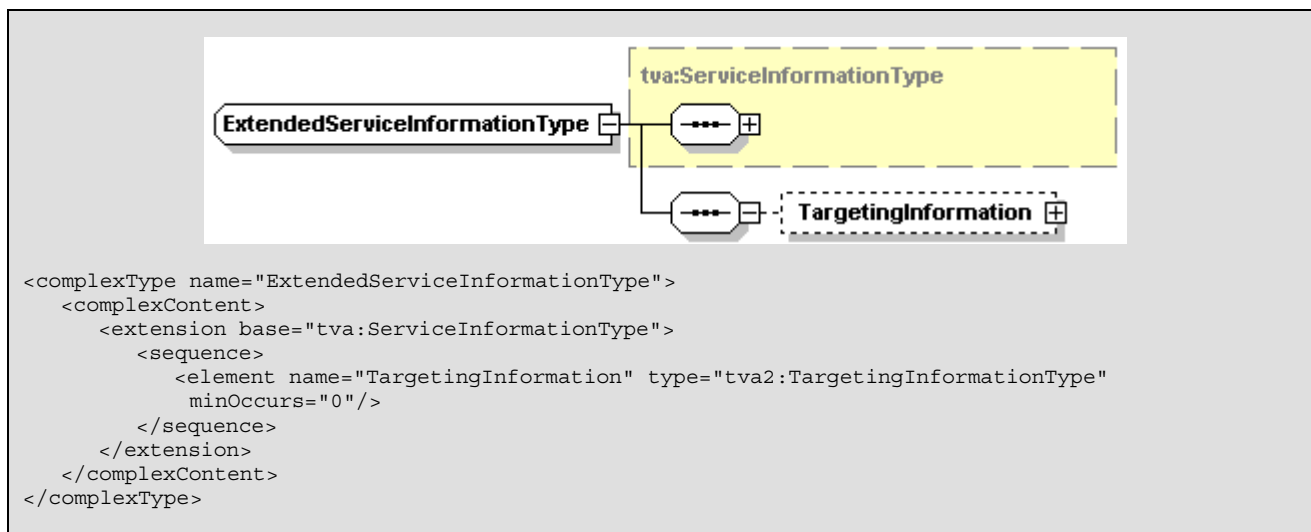

Name	Definition
ExtendedServiceInformationType	A complex type that extends the phase 1 ServiceInformationType.
TargetingInformation	Information about the target user group and required usage environment for the service.

8 Content package description

8.1 Introduction

A package is defined as a collection of items, where an item is a consumable entity, and the terminal/user is able to select between the various items of a package, therefore personalizing the end experience.

An item is made up of one or more components, which again can be selected depending on such criteria as:

- the terminal capabilities;
- the user preferences;
- the user input.

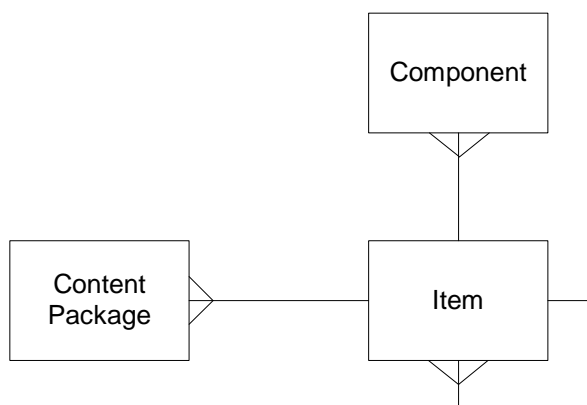
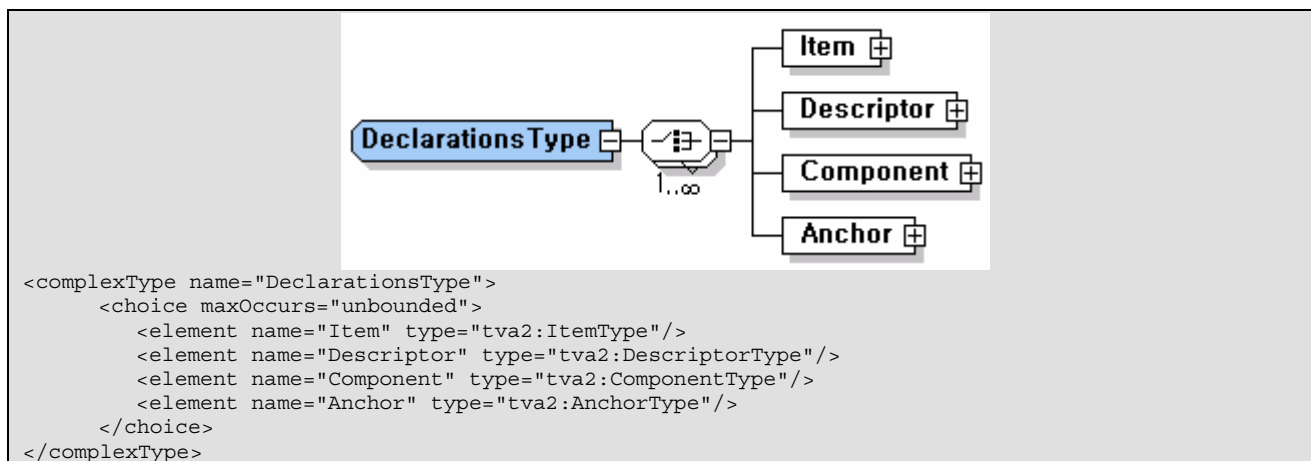

Figure 3: Content package data model

8.2 Declarations

The following defines the syntax and semantics for the declarations. Declarations are used to define items, descriptors, components, and anchors, which are elements of a package so that, within the same document, those elements can be referenced more than once by using ReferenceType to compose the package.



Name	Definition
DeclarationsType	A complex type used to represent a Declarations element that is used to define a set of Package elements (such as Item, Component, Descriptor, and Anchor) - without instantiating them - for later use in a document by using ReferenceType.
Item	An element that represents an Item which is a grouping of possible sub-Items and/or Components, bound to a set of relevant Descriptors containing descriptive information about the item.
Descriptor	A descriptive information that is used for package, item, component, anchor, choice and selection.
Component	An element that consists of a Resource or a set of Anchors with a set of relevant Descriptors containing descriptive information about the component.
Anchor	An element that binds Descriptors to a specific location or part of a resource identified by the Resource element.

8.3 Descriptor

The following defines the syntax and semantics for the descriptor. A descriptor is used to associate descriptive data with a parent element which can be a package, an item, a component, an anchor, a choice or a selection.

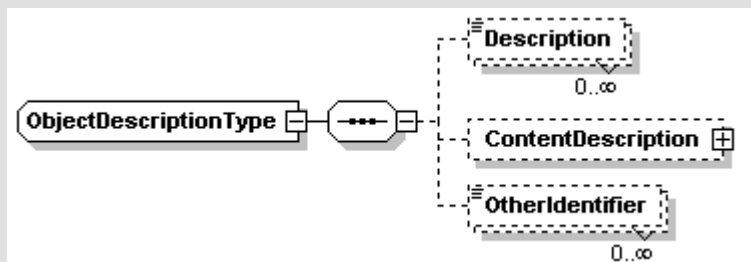

```
<complexType name="ObjectDescriptionType">
  <sequence>
    <element name="Description" type="mpeg7:TextualType" minOccurs="0"
      maxOccurs="unbounded"/>
    <element name="ContentDescription" type="tva2:ExtendedContentDescriptionType"
      minOccurs="0"/>
    <element name="OtherIdentifier" type="mpeg7:UniqueIDType" minOccurs="0"
      maxOccurs="unbounded"/>
  </sequence>
</complexType>
```

```
<complexType name="ConditionType">
  <attribute name="require" type="tva:TVAIDRefsType"/>
  <attribute name="except" type="tva:TVAIDRefsType"/>
</complexType>
```

```
<complexType name="ReferenceType">
  <attribute name="target" type="tva:TVAIDRefType" use="required"/>
</complexType>
```

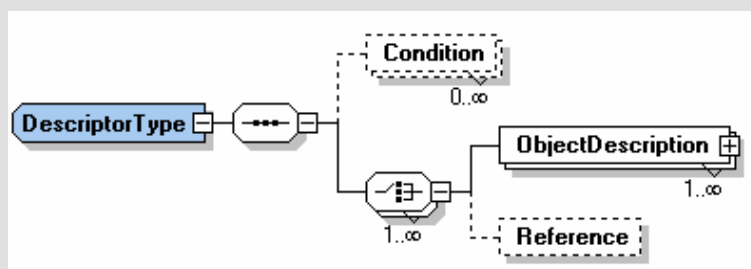

```
<complexType name="DescriptorType">
  <sequence>
    <element name="Condition" type="tva2:ConditionType" minOccurs="0"
      maxOccurs="unbounded"/>
    <choice maxOccurs="unbounded">
      <element name="ObjectDescription" type="tva2:ObjectDescriptionType"/>
      <element name="Reference" type="tva2:ReferenceType"/>
    </choice>
  </sequence>
  <attribute name="descriptor_id" type="tva:TVAIDType" use="optional"/>
  <attribute ref="xml:lang" use="optional"/>
</complexType>
```

Name	Definition
ObjectDescriptionType	A complex type that defines descriptive information related to content.
Description	Textual description for the content.
ContentDescription	The description of the content.
OtherIdentifier	An element to allow associating additional private identifiers e.g. for use in private downstream environments.

Name	Definition
ConditionType	A complex type that defines a <i>Condition</i> which denotes the parent element as being conditional on a set of predicate tests. Multiple <i>predicates</i> within a <i>Condition</i> are combined as a conjunction (an AND relationship). Any <i>predicate</i> can be negated within a <i>Condition</i> . Multiple <i>conditions</i> associated with a given parent element are combined as a disjunction (an OR relationship) when determining whether to include the element.
require	An attribute listing the set of <i>predicates</i> that shall become true in order for the <i>Condition</i> to be satisfied. Each <i>predicate</i> is identified by the value of the <i>select_id</i> attribute in a <i>Selection</i> element located somewhere within an <i>Item</i> element that is an ancestor of the <i>Condition</i> .
except	An attribute listing the set of <i>predicates</i> that shall become false in order for the <i>Condition</i> to be satisfied. Each <i>predicate</i> is identified by the value of the <i>select_id</i> attribute in a <i>Selection</i> element located somewhere within an <i>Item</i> element that is an ancestor of the <i>Condition</i> .
ReferenceType	A complex type that represents a reference to one of the following package elements: <i>Item</i> , <i>Component</i> , <i>Descriptor</i> , or <i>Anchor</i> . It has to represent a reference to another element located somewhere within the same document (note that referencing any element belonging to its own sibling elements or children of them is not allowed). Semantically, a reference links the contents of the referenced element (the element identified by the value of the <i>Reference</i> 's <i>target</i> attribute) to the existing contents of the referring element (the <i>Reference</i> 's parent element). In addition, the values of any attributes not specified in the referring element are inherited from the referent element. The <i>Reference</i> allows a document author to maintain a single source for an element that occurs in more than one place within the same document.
target	An ID identifying the referent element. For example, ID of <i>Item</i> , <i>Descriptor</i> , <i>Component</i> , or <i>Anchor</i> defined in <i>Declarations</i> can be an ID for <i>target</i> to be referenced.
DescriptorType	A complex type to define <i>Descriptor</i> that associates information with its following parent element: <i>Package</i> , <i>Item</i> , <i>Component</i> , <i>Descriptor</i> , <i>Anchor</i> , <i>Choice</i> , and <i>Selection</i> .
Condition	A descriptor may be conditional via a set of <i>Condition</i> elements (on predicates asserted by <i>Selections</i> defined in the <i>Choices</i>). A <i>Descriptor</i> element cannot be conditional on any of its descendant <i>Selection</i> elements.
ObjectDescription	Descriptive information related to content.
Reference	Indicates a reference to a <i>Descriptor</i> that is located somewhere within the same document. See <i>ReferenceType</i> .
descriptor_id	A unique ID value of a <i>Descriptor</i> that can be referenced in <i>Reference</i> element.
xml:lang	Specifies the language of the description.

8.4 Item

An item represents a multimedia experience as an unit of consumption. For example, it may be a video/audio clip, for which there is a choice between different encoding formats. In addition, an item itself can contain further items which allow the further refinement of the multimedia experience. For example, in the case of an interactive sports application that enables the user to view a football match from different camera angles, there would be a top-level item that defines the interactive sports experience. This item could then contain a further item that allows the selection of the video encoding format based on receiver capabilities.

The *primaryComponent* attribute is only allowed to reference the *component_id* of a *Component* that is (lexically speaking) a child element of the *Item* in question. This avoids problems to do with overriding another *Item*'s primary *Component* when using the <*Reference*> mechanism.

The following defines the syntax and semantics for the item.

```
<complexType name="SelectionType">
  <sequence>
    <element name="Condition" type="tva2:ConditionType" minOccurs="0"
      maxOccurs="unbounded"/>
    <element name="Descriptor" type="tva2:DescriptorType" minOccurs="0"
      maxOccurs="unbounded"/>
  </sequence>
  <attribute name="select_id" type="tva:TVAIDType" use="required"/>
</complexType>
```

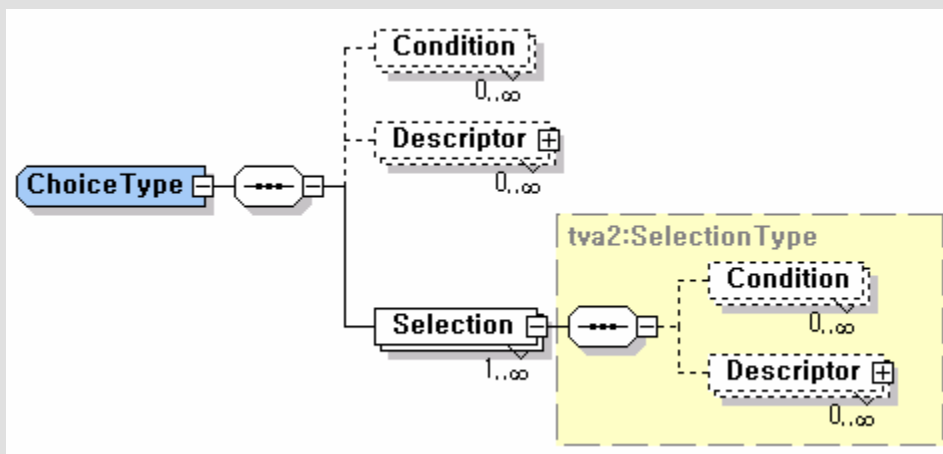

```
<complexType name="ChoiceType">
  <sequence>
    <element name="Condition" type="tva2:ConditionType" minOccurs="0"
      maxOccurs="unbounded"/>
    <element name="Descriptor" type="tva2:DescriptorType" minOccurs="0"
      maxOccurs="unbounded"/>
    <element name="Selection" type="tva2:SelectionType" maxOccurs="unbounded"/>
  </sequence>
  <attribute name="minSelections" type="nonNegativeInteger"/>
  <attribute name="maxSelections" type="positiveInteger"/>
  <attribute name="default" type="tva:TVAIDRefsType"/>
  <attribute name="choice_id" type="tva:TVAIDType"/>
</complexType>
```

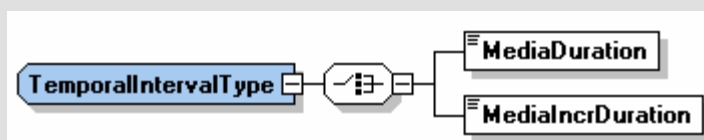

```
<complexType name="TemporalIntervalType">
  <choice>
    <element name="MediaDuration" type="mpeg7:mediaDurationType"/>
    <element name="MediaIncrDuration" type="mpeg7:MediaIncrDurationType"/>
  </choice>
</complexType>
```

```
<simpleType name="SpatialRelIntervalType">
  <restriction base="string">
    <pattern value="-?S((\d+N) (\d+F))?" />
  </restriction>
</simpleType>
```

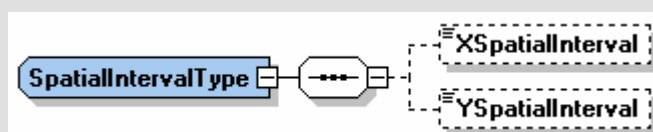

```

<complexType name="SpatialIntervalType">
  <sequence>
    <element name="XSpatialInterval" type="nonNegativeInteger" minOccurs="0"/>
    <element name="YSpatialInterval" type="nonNegativeInteger" minOccurs="0"/>
  </sequence>
  <attribute name="spatialIntervalUnit" type="tva2:SpatialRelIntervalType"/>
</complexType>

```

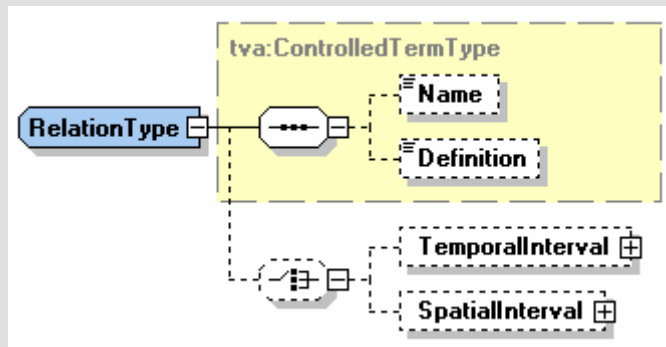

```

<complexType name="RelationType">
  <complexContent>
    <extension base="tva:ControlledTermType">
      <choice minOccurs="0">
        <element name="TemporalInterval" type="tva2:TemporalIntervalType"
minOccurs="0"/>
        <element name="SpatialInterval" type="tva2:SpatialIntervalType"
minOccurs="0"/>
      </choice>
      <attribute name="source" type="tva:TVAIDRefsType" use="optional"/>
      <attribute name="target" type="tva:TVAIDRefsType" use="optional"/>
    </extension>
  </complexContent>
</complexType>

```

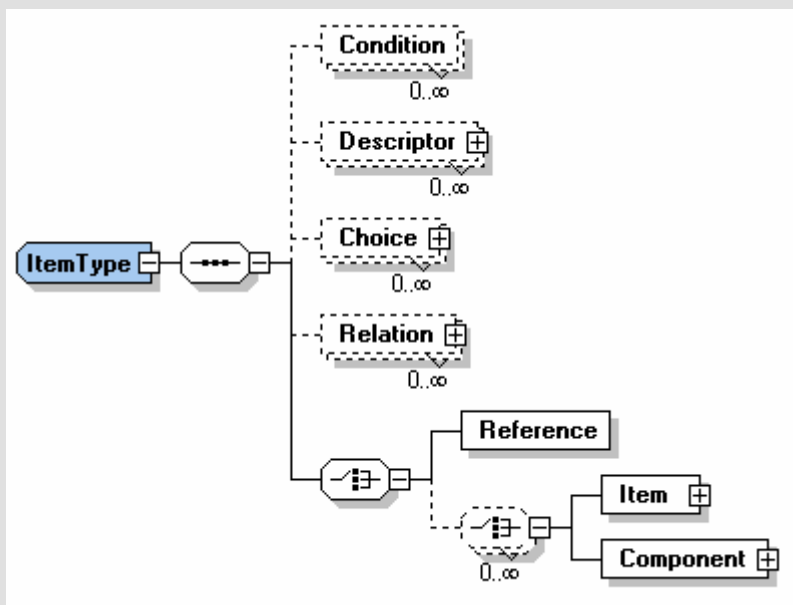

```

<complexType name="ItemType">
  <sequence>
    <element name="Condition" type="tva2:ConditionType" minOccurs="0"
maxOccurs="unbounded"/>
    <element name="Descriptor" type="tva2:DescriptorType" minOccurs="0"
maxOccurs="unbounded"/>
    <element name="Choice" type="tva2:ChoiceType" minOccurs="0" maxOccurs="unbounded"/>
    <element name="Relation" type="tva2:RelationType" minOccurs="0"
maxOccurs="unbounded"/>
    <choice>
      <element name="Reference" type="tva2:ReferenceType"/>
      <choice minOccurs="0" maxOccurs="unbounded">
        <element name="Item" type="tva2:ItemType"/>

```

```

    <element name="Component" type="tva2:ComponentType"/>
  </choice>
</choice>
</sequence>
<attribute name="item_id" type="tva:TVAIDType" use="optional"/>
<attribute name="primaryComponent" type="tva:TVAIDRefType" use="optional"/>
<attribute ref="xml:lang" use="optional"/>
</complexType>

```

Name	Definition
SelectionType	A complex type that defines a <i>Selection</i> consisting of <i>Condition</i> and/or descriptive information (<i>Descriptor</i>) required to make a specific decision that will affect one or more <i>Conditions</i> somewhere within an <i>Item</i> . If the <i>Selection</i> is chosen, its <i>predicate</i> becomes true; if it is not chosen, its <i>predicate</i> becomes false; if it is left unresolved, its <i>predicate</i> is undecided. Note that <i>Selections</i> and entire <i>Choices</i> may be made conditional (i.e. they may have one or more <i>Condition</i> child elements). This makes it possible to implement complex decision trees in which certain selections may make certain subsequent <i>Choices</i> or <i>Selections</i> redundant. For example, a <i>PackageTable</i> document might contain a <i>Choice</i> on whether to include a supplemental video clip, followed by a <i>Choice</i> on the encoding preference of the video clip. If, during configuration time, the video clip selection is rejected, then the encoding preference <i>Choice</i> should be skipped.
Condition	An element to represent a <i>Condition</i> . In this case, it denotes the parent <i>Selection</i> element as being conditional on a set of <i>predicate</i> tests. If the condition is satisfied, the <i>Selection</i> can be considered to be chosen.
Descriptor	A descriptive information about the selection, which can be used to decide whether to choose the <i>Selection</i> .
select_id	An ID value that identifies the <i>predicate</i> embodied by the <i>Selection</i> , and can be referenced in one or more <i>Conditions</i> somewhere within an <i>Item</i> and/or <i>Component</i> so that the <i>Selection</i> element allows <i>Condition</i> elements to be associated with specific selections.
ChoiceType	A complex type that defines a <i>Choice</i> encapsulating a set of related <i>Selections</i> that can affect the configuration of an <i>Item</i> . For example, in case of a <i>Choice</i> for audio encoding format, one <i>Selection</i> can be MP3 encoding format and the other <i>Selection</i> can be WAV encoding format. The client system may select first supportable selection and may not check the rest of selections listed in the choice. It is recommended to list the selections in the order of importance.
Condition	It denotes the parent <i>Choice</i> element as being conditional on a set of <i>predicate</i> tests. If the condition is satisfied, <i>Selections</i> under the <i>Choice</i> can be considered to be chosen.
Descriptor	A descriptive information about the choice.
Selection	A specific decision about a particular choice such as MP3 or WAV encoding format.
minSelections	Minimum number of selections that shall be made. If not present, there is no minimum number.
maxSelections	Maximum number of selections that shall be made. If not present, there is no maximum number.

Name	Definition
default	Denotes a list of ID values defined in <code>select_id</code> of <code>Selection</code> within the <code>Choice</code> to indicate the set of default selections for the <code>Choice</code> . If the <code>default</code> attribute is specified, the number of individual values in the <code>default</code> attribute may not be less than the value of the <code>minselections</code> , no more than the value of the <code>maxselections</code> .
choice_id	An attribute that uniquely identifies the choice.
TemporalIntervalType	A complex type that Indicates relative temporal distance between Items and/or components.
MediaDuration	This element is used to signal a duration using a days, hours, minutes, seconds and fractions of seconds. See MPEG-7 MDS specification (ISO/IEC 15938-5 [16]).
MediaIncrDuration	This element is used to signal a duration using declared <code>mediaTimeUnits</code> . See MPEG-7 MDS specification (ISO/IEC 15938-5 [16]).
SpatialRelIntervalType	A simple type used to indicate either one-hundredth part or one-thousandth part. (e.g. S1N1000F = 1/1000).
SpatialIntervalType	A complex type that Indicates relative spatial distance between Items and/or components. The spatial distance is relative distance based on initial display size (e.g. in case of having screen size of 960x540 and spatial distance of (500,10), the spatial distance would be specified as (500/960, 10/540).) The relative distance can be either one-hundredth part or one-thousandth part.
XSpatialInterval	This element is used to signal a relative distance in x-axis (horizontal axis) based on initial display size.
YSpatialInterval	This element is used to signal a relative distance in y-axis (vertical axis) based on initial display size.
spatialIntervalUnit	This element is used to indicate if the spatial distance is one-hundredth part or one-thousandth part.
RelationType	A complex type that defines spatial and temporal relation between source and target. Source and target can be items or components.
TemporalInterval	Indicates relative temporal distance from source to target. Source/target can be items or components. For example, in case of temporal relation between A and B, if B follows A after 3 seconds, it can be described that source is A, target is B, and relation is "follows" with temporal distance of 3 seconds (Or source is B, target is A, and relation is "precedes" with temporal distance of -3 seconds).
SpatialInterval	Indicates spatial distance from source to target. Source/target can be items or components. The spatial distance is relative distance based on initial display size. For example. in case of having screen size of 960x540, if B is located in northwest direction of A with spatial distance of (500,10), it can be described that source is A, target is B, and spatial relation is "northwest" with the spatial distance of (500/960, 10/540). The relative distance can be either one-hundredth part or one-thousandth part.
source	Specifies reference items or components to measure relative temporal/spatial distance. Source can be multiple items or components when multiple items or components have same reference position in temporal or spatial domain. For example, if A and B starts at the same time, it can be described that sources are A and B and relation is "CoBegin". For example, an "include" relation can have multiple sources and a single target to indicate multiple objects that appear in a single target object.
target	Specifies target items or components to measure relative temporal/spatial distance from the reference items or components.

Name	Definition
ItemType	<p>A complex type that defines an <code>Item</code> that is a grouping of possible sub-Items and/or Components, bound to relevant Descriptors. In addition, an <code>Item</code> may contain Conditions, Choices, and Relations.</p> <p>An item that contains no sub-Items can be considered an entity a logically indivisible work. An <code>Item</code> that does contain sub-Items can be considered as compilation -- a work composed of potentially independent sub-parts.</p> <p>Relations indicate relation between Items/components.</p>
Condition	<p>A set of <i>predicate</i> tests for choosing the item.</p> <p>An <code>Item</code> may be conditional via a set of <code>Condition</code> elements (on <i>predicates</i> asserted by <code>Selections</code> defined in the <code>Choices</code>).</p> <p>An <code>Item</code> element cannot be conditional on any of its descendant <code>Selection</code> elements.</p>
Descriptor	A descriptive information about the item.
Choice	A set of related selections that can affect the configuration of an item.
Relation	Indicates relative spatial/temporal relation between items and components.
Reference	Indicates a reference to an <code>Item</code> that is located somewhere within the same document. See <code>ReferenceType</code> .
Item	<p>An <code>Item</code> is a grouping of possible sub-Items and/or Components, bound to a set of relevant Descriptors containing descriptive information about item. In addition, an <code>Item</code> may contain Choices, Conditions, and Relations.</p>
Component	<p>A <code>Component</code> element contains a <code>Resource</code> or a set of <code>Anchors</code> with a set of relevant Descriptors containing descriptive information about the component.</p>
item_id	A unique ID value of an <code>Item</code> that can be referenced in <code>Reference</code> element.
primaryComponent	An attribute to specify which is the primary or "main" <code>Component</code> of the item.
xml:lang	Specifies the language of the description.

NOTE: The system may process the Choice/Selection mechanism in the order of listing. Therefore, it is recommended to list the Choice/Selections which may affect overall consumption of the package at the top level of description. If the Choice/Selection only affects certain set of items, it is recommended to list the proper Choice/Selection at the appropriate item level.

8.5 Component

Figure 4 shows an example of the temporal relations between items and components. With the relation description defined in RelationType, the relative temporal relation between items and/or components in a package can be described.

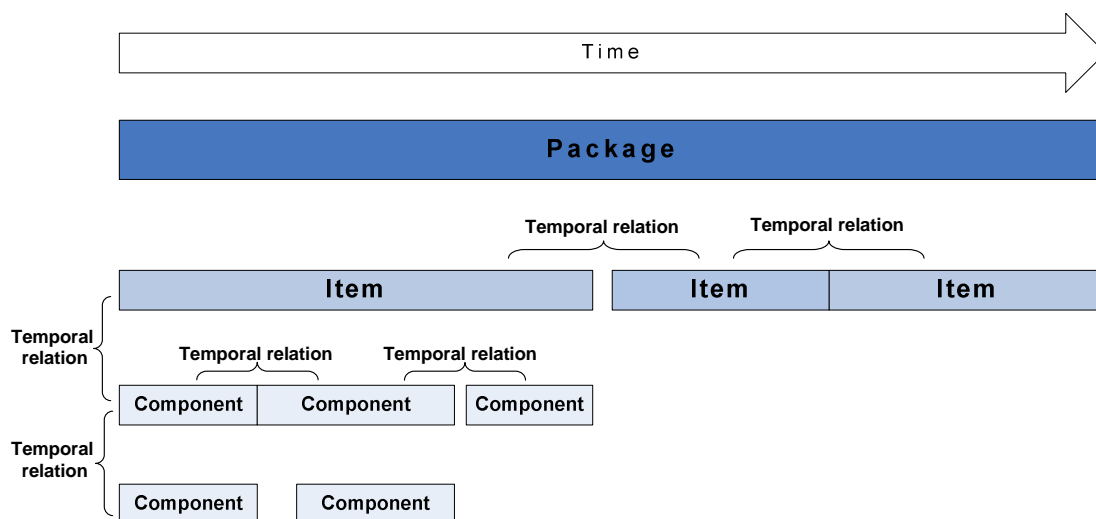
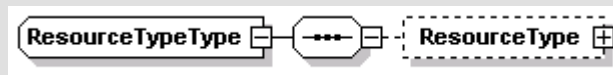

Figure 4: Temporal relations between items and components

The following defines the syntax and semantics for the component which is a single acquirable entity which is a resource. It could, for example, be a MPEG 2 video/audio file, or it could be an audio stream. One or more "components" form an "item".

```
<simpleType name="InstanceMetadataIdListType">
  <list itemType="tva:InstanceMetadataIdType"/>
</simpleType>
```



```
<complexType name="ResourceTypeType">
  <sequence>
    <element name="ResourceType" type="tva:ControlledTermType" minOccurs="0"
      maxOccurs="1" />
  </sequence>
  <attribute name="crId" type="tva:CRIDType" use="required"/>
  <attribute name="imi" type="tva2:InstanceMetadataIdListType" use="optional"/>
</complexType>
```

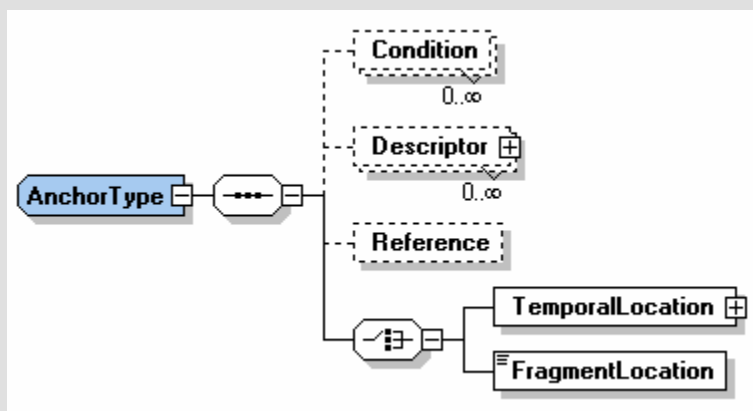

```
<complexType name="AnchorType">
  <sequence>
    <element name="Condition" type="tva2:ConditionType" minOccurs="0"
      maxOccurs="unbounded"/>
    <element name="Descriptor" type="tva2:DescriptorType" minOccurs="0"
      maxOccurs="unbounded"/>
    <element name="Reference" type="tva2:ReferenceType" minOccurs="0"/>
  </sequence>
  <attribute name="crId" type="tva:CRIDType" use="required"/>
  <attribute name="imi" type="tva2:InstanceMetadataIdListType" use="optional"/>
</complexType>
```

```

<choice>
  <element name="TemporalLocation" type="tva:TVATimeType"/>
  <element name="FragmentLocation" type="string"/>
</choice>
</sequence>
<attribute name="anchor_id" type="tva:TVAIDType" use="optional"/>
</complexType>

```

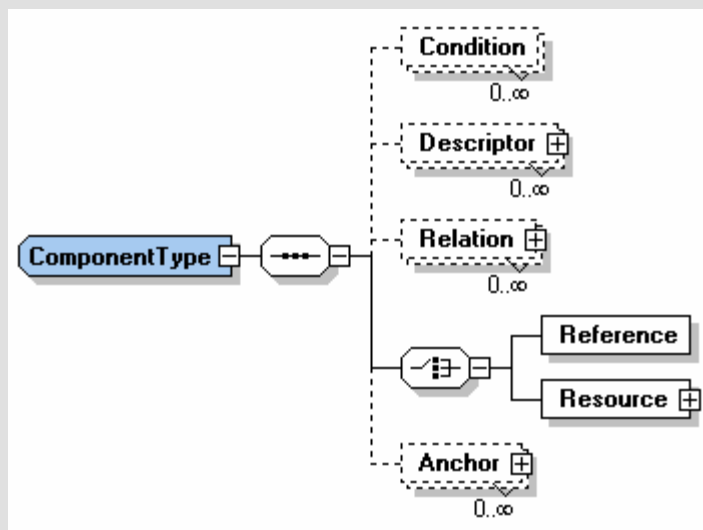

```

<complexType name="ComponentType">
  <sequence>
    <element name="Condition" type="tva2:ConditionType" minOccurs="0"
      maxOccurs="unbounded"/>
    <element name="Descriptor" type="tva2:DescriptorType" minOccurs="0"
      maxOccurs="unbounded"/>
    <element name="Relation" type="tva2:RelationType" minOccurs="0"
      maxOccurs="unbounded"/>
    <choice>
      <element name="Reference" type="tva2:ReferenceType"/>
      <element name="Resource" type="tva2:ResourceTypeType"/>
    </choice>
    <element name="Anchor" type="tva2:AnchorType" minOccurs="0" maxOccurs="unbounded"/>
  </sequence>
  <attribute name="component_id" type="tva:TVAIDType" use="optional"/>
  <attribute ref="xml:lang" use="optional"/>
</complexType>

```

Name	Definition
InstanceMetadataIdListType	A simple type used to specify the list of instance metadata identifier(IMI)s.
ResourceTypeType	A complex type to indicate individually identifiable asset, a resource, such as a video or audio clip, an image, or a textual asset which can be a component. A Resource is identified by CRID value + 0 or more IMI(s).
ResourceType	Indicates the type of the resource (e.g. "video/mpeg").
crid	The CRID value that identifies the Resource.
imi	An optional list of instance metadata identifier(IMI)s. Each of them shall identify particular location of the content related to a CRID. IMI with CRID enables identification of different bit-represented instances (resulting from different encoding type, format, etc.) of the component for targeting. Multiple IMIs are used to list the instances which have bit identical representation and are located in different place.
AnchorType	A complex type that defines an Anchor. An Anchor binds a set of Descriptors to a specific location or range within the resource identified by Resource element specified within the parent Component element.

Name	Definition
Condition	A set of predicate tests for choosing the anchor which is a fragment of resource. The satisfied condition indicates that the anchor is selected to be consumed. An anchor, which is a fragment of resource, may be conditional via a set of Condition elements (on <i>predicates</i> asserted by Selections defined in the Choices).
Descriptor	A descriptive information about the anchor that can be referenced in Reference element.
Reference	A reference to the Anchor that is located somewhere within the same document. See the ReferenceType.
TemporalLocation	A element to be used to locate the part of interest within the associated resource by using TVATimeType.
Fragmentlocation	A string that, when appended to the value of the URI attribute of the associated Resource element (specified within the parent Component element), followed by a pound sign ("#"), locates the part of interest within the associated resource.
anchor_id	A unique ID value of an Anchor that can be referenced in Reference element.
ComponentType	A complex type that defines a Component consisting of a Resource, bound to a set of Descriptors. In addition, a Component may contain Conditions, Relations, and Anchors. Descriptors contain descriptive information about the Component, as a representation of a work. A Component may be conditional via a set of Condition elements (on <i>predicates</i> asserted by Selections defined in the Choices). Relations indicate relation between Items/Components. It should be noted that a component itself is not an Item; components are building blocks of Items. A component includes a resource (it shall not include more than one resource).
Condition	A set of <i>predicate</i> tests for choosing the Component. A component may be conditional via a set of Condition elements (on <i>predicates</i> asserted by Selections defined in the Choices).
Descriptor	A descriptive information about the component.
Relation	Indicates relative spatial/temporal relation between items and components.
Reference	Indicates a reference to a component that is located somewhere within the same instance document. See the ReferenceType.
Resource	An individually identifiable asset that a component consists of. See the ResourceType.
Anchor	Element that binds Descriptors to a specific location or range within the resource identified by the Resource element specified in the parent Component element.
component_id	A unique ID value of a Component that can be referenced in Reference element.
xml:lang	Specifies the language of the description.

The following shows an example instance of anchor. In this example, user can watch from the starting point of the first goal scene or second goal scene in World Cup video sequence by selecting either First_Goal or Second_Goal.

```
<?xml version="1.0" encoding="UTF-8"?>
<TVAMain xmlns="urn:tva:metadata:2007" xmlns:tva2="urn:tva:metadata:extended:2007"
xmlns:int="urn:tva:metadata:interstitial:2007" xmlns:mpeg21="urn:tva:mpeg21:2007"
xmlns:mpeg7="urn:tva:mpeg7:2005" xmlns:rmpi="urn:tva:rmpi:2005" xmlns:tva="urn:tva:metadata:2007"
xmlns:xsi="http://www.w3.org/2001/XMLSchema-instance"
xsi:schemaLocation="urn:tva:metadata:extended:2007 tva2_metadata_3-3_v121.xsd"
xsi:type="tva2:ExtendedTVAMainType">
  <tva2:PackageTable>
    <tva2:Package crid="//foo.com/Package/12-1-2005">
      <tva2:Item>
        <tva2:Choice choice_id="Goal_Choice" minSelections="0" maxSelections="1">
```

```

    <tva2:Selection select_id="First_Goal">
      <tva2:Descriptor>
        <tva2:ObjectDescription>
          <tva2:ContentDescription>
            <Title>First Goal in World Cup</Title>
          </tva2:ContentDescription>
        </tva2:ObjectDescription>
      </tva2:Descriptor>
    </tva2:Selection>
    <tva2:Selection select_id="Second_Goal">
      <tva2:Descriptor>
        <tva2:ObjectDescription>
          <tva2:ContentDescription>
            <Title>Second Goal in World Cup</Title>
          </tva2:ContentDescription>
        </tva2:ObjectDescription>
      </tva2:Descriptor>
    </tva2:Selection>
  </tva2:Choice>
</tva2:Component>
<tva2:Component>
  <tva2:Resource crid="CRID://foo.com/WORLDCUP_Video"/>
  <tva2:Anchor>
    <tva2:Condition require="First_Goal"/>
    <tva2:TemporalLocation>
      <TimePoint>T00:15:01:235F1000</TimePoint>
    </tva2:TemporalLocation>
  </tva2:Anchor>
  <tva2:Anchor>
    <tva2:Condition require="Second_Goal"/>
    <tva2:TemporalLocation>
      <TimePoint>T00:37:01:172F1000</TimePoint>
    </tva2:TemporalLocation>
  </tva2:Anchor>
</tva2:Component>
</tva2:Item>
</tva2:Package>
</tva2:PackageTable>
</TVAMain>

```

8.6 Package

A package is defined as a collection of content components that in some combination (either all or a subset) together provide a consumer experience and are intended to be used together. A package can be instantiated with or without main AV content depending on scenarios, in which main AV content and package can be tightly associated or can be loosely coupled enough to be handled (generation, delivery, consumption) independently.

When a package is instantiated with main AV content, the description of main AV content is provided by using ProgramInformationTable.

A package consists of a set of content items and components, and provides a decision tree, where the device and user can make choices depending upon usage environment and required user experience.

A package is a structure that allows items to be grouped. The Package element may contain an optional Declarations element, a grouping of Items, and a set of Descriptors that contains descriptive information about the package.

The following describes the structure of a package.

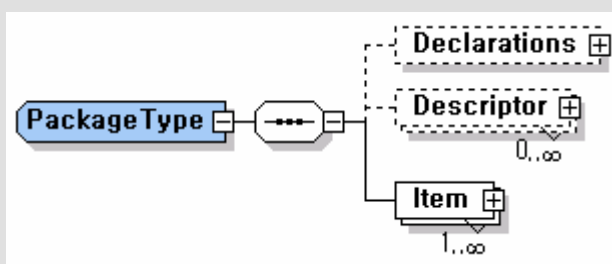

```

<complexType name="PackageType">
  <sequence>

```

```

<element name="Declarations" type="tva2:DeclarationsType" minOccurs="0"/>
<element name="Descriptor" type="tva2:DescriptorType" minOccurs="0"
maxOccurs="unbounded"/>
  <element name="Item" type="tva2:ItemType" maxOccurs="unbounded"/>
</sequence>
<attribute name="crid" type="tva:CRIDType" use="required"/>
<attributeGroup ref="tva:fragmentIdentification"/>
  <attribute ref="xml:lang" use="optional"/> <attribute name="serviceIDRef"
type="tva:TVAIDRefsType" use="optional"/>
</complexType>

```

Name	Definition
PackageType	A complex type that specifies a package that is a group of items.
Declarations	Declarations element is used to define a set of package elements in a document without actually instantiating them. A declared element (i.e. a child element of a Declarations element) is not considered to be instantiated unless it is referenced (by a Reference element).
Descriptor	A descriptive information about the package.
Item	A grouping of possible sub-Items and/or Components.
crid	The CRID for the package.
fragmentIdentification	Used to identify the fragment of data to which this description belongs.
xml:lang	Specifies the language of the description.
serviceIDRef	An attribute <i>to</i> enable a package to be attributed to one or more particular ServiceInformation fragments.

9 Extended user description datatypes

The present clause defines consumer metadata extended to describe consumer and consumer's environments supporting targeting and compatibility with Phase 1 user description metadata.

NOTE: Clause 5.5 of TS 102 822-3-2 [4] provides more detailed information on *TV-Anytime* consumer metadata including User Preferences and Usage History.

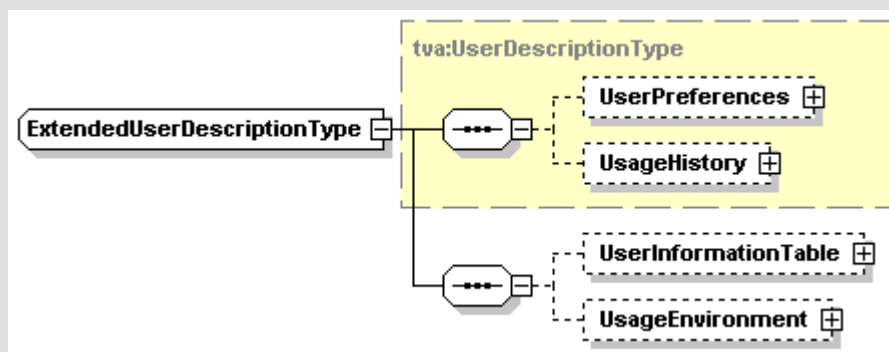

```

<complexType name="ExtendedUserDescriptionType">
  <complexContent>
    <extension base="tva:UserDescriptionType">
      <sequence>
        <element name="UserInformationTable" type="tva2:UserInformationTableType" minOccurs="0"/>
        <element name="UsageEnvironment" type="tva2:UsageEnvironmentDescriptionType" minOccurs="0"/>
      </sequence>
    </extension>
  </complexContent>
</complexType>

```

Name	Definition
ExtendedUserDescriptionType	Defines extended consumer metadata.
UserInformationTable	Describes the consumer's information including biographic information and the accessibility information.
UsageEnvironment	Describes the environment of content consumption.

10 Information tables

10.1 Package table

A package is defined as a collection of content components that in some combination (either all or a subset) together provide a consumer with an enriched experience. A package can be instantiated with or without main AV content depending on scenarios, in which main AV content and a package can be tightly associated or can be coupled loosely enough to be handled (generation, delivery, consumption) independently.

When a package is instantiated with main AV content, the description of main AV content is provided by using the ProgramInformationTable.

A package consists of a set of content items and components, and provides a decision tree, where the device and user can make choices depending upon usage environment and required user experience.

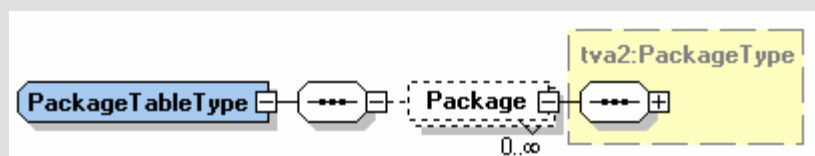

```

<complexType name="PackageTableType">
  <sequence>
    <element name="Package" type="tva2:PackageType" minOccurs="0" maxOccurs="unbounded"/>
  </sequence>
  <attribute ref="xml:lang" use="optional"/>
  <attribute name="copyrightNotice" type="string" use="optional"/>
</complexType>

```

Name	Definition
PackageTableType	A complex type that describes a table of package records.
Package	A list of package records. A <i>Package</i> has <i>PackageType</i> .
xml:lang	Specifies the language of the description.
copyrightNotice	Specifies the copyright information for the PackageTable.

10.2 Interstitial campaign table

The interstitial campaign table is used to hold information about campaigns for which interstitial content descriptions are provided.

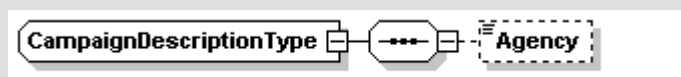

```

<complexType name="CampaignDescriptionType">
  <sequence>
    <element name="Agency" type="string" minOccurs="0" />
  </sequence>
  <attribute name="campaignId" type="tva:TVAIDType" use="required"/>
  <attribute name="startdate" type="dateTime" use="optional"/>
  <attribute name="enddate" type="dateTime" use="optional"/>
</complexType>

```

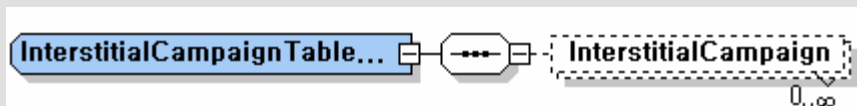

```
<complexType name="InterstitialCampaignTableType">
  <sequence>
    <element name="InterstitialCampaign" type="tva2:CampaignDescriptionType" minOccurs="0"
maxOccurs="unbounded"/>
  </sequence>
</complexType>
```

Name	Definition
CampaignDescriptionType	A complex type that describes an interstitial campaign.
Agency	Free text to allow the identification of the Agency carrying the campaign.
campaignId	A unique identifier for the Campaign. This field is referenced by the MemberOfCampaign element within the InterstitialContextAttributesType.
startdate	The inclusive date at which the campaign will start.
enddate	The inclusive date at which the campaign will end.
InterstitialCampaignTableType	A complex type that describes a table of InterstitialCampaign.
InterstitialCampaign	A list of InterstitialCampaign elements.

10.3 Rights Management and Protection Information (RMPI) table

The present clause describes how to enable rights information compliant with tva_rmpi.xsd [7] to be associated with content descriptions. The purpose is solely to provide a mechanism to inform end users of the rights associated with content - i.e. it is "attractor" information, and not intended to be the basis of any enforcement mechanism. A means is also provided to associate content descriptions with external rights documents expressed in non-TV-Anytime formats.

Where the same rights related information may be applicable to several content items, a table is provided to enable this information to be declared once and referenced from within content descriptions.

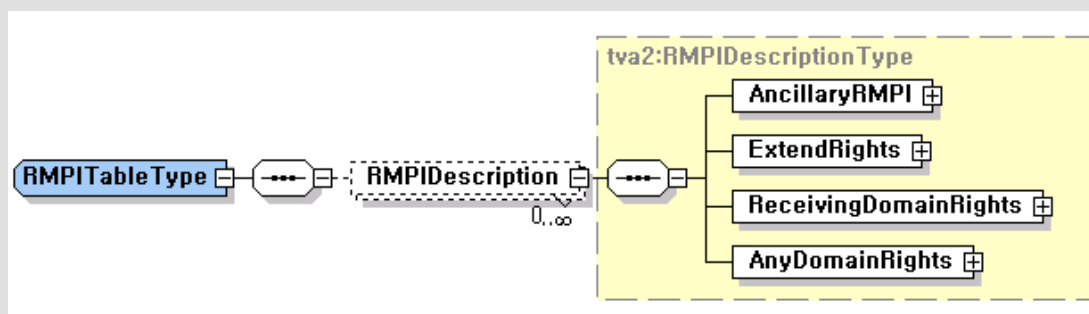

```
<complexType name="RMPIDescriptionType">
  <complexContent>
    <extension base="rmpi:RMPI-MBAndMType">
      <attribute name="RMPIDescriptionId" type="tva:TVAIDType" use="required"/>
    </extension>
  </complexContent>
</complexType>

<complexType name="RMPITableType">
  <sequence>
    <element name="RMPIDescription" type="tva2:RMPIDescriptionType" minOccurs="0"
maxOccurs="unbounded"/>
  </sequence>
  <attribute ref="xml:lang" use="optional"/>
</complexType>
```

Name	Definition
RMPIDescriptionType	A complex type that specifies description to be used for direct incorporation of TVA-compliant RMPI information in a content description.
RMPIDescriptionId	An id for RMPIDescription.
RMPITableType	A complex type that describes a table of RMPI description records.
RMPIDescription	This element is used for direct incorporation of TVA-compliant RMPI information in a content description.
xml:lang	Specifies the language of the description.

10.4 Coupon table

This table contains the coupon descriptions which are stand-alone, this means not included in the "PurchaseList" of a "BasicContentDescription".

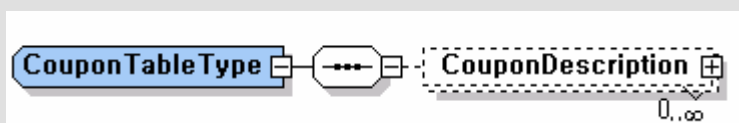

```
<complexType name="CouponTableType">
  <sequence>
    <element name="CouponDescription" type="tva2:CouponDescriptionType" minOccurs="0"
      maxOccurs="unbounded"/>
  </sequence>
  <attribute ref="xml:lang" use="optional"/>
</complexType>
```

Name	Definition
CouponTableType	A complex type that describes a table of coupon description records.
CouponDescription	This element contains the coupon description.
xml:lang	Specifies the language of the description.

10.5 Targeting information table

This table contains the targeting information.

```
<complexType name="TargetingInformationTableType">
  <sequence>
    <element name="TargetingInformation" type="tva2:TargetingInformationType"
      minOccurs="0" maxOccurs="unbounded"/>
  </sequence>
</complexType>
```

Name	Definition
TargetingInformationTableType	A complex type that serves as a container for globally declared Targeting Information.
TargetingInformation	An instantiation of a set of Targeting Information.

11 Extended *TV-Anytime* information document

The following extends the TVAMain type developed in TS 102 822-3-1 [3] to enable the instantiation of the extended schema type.

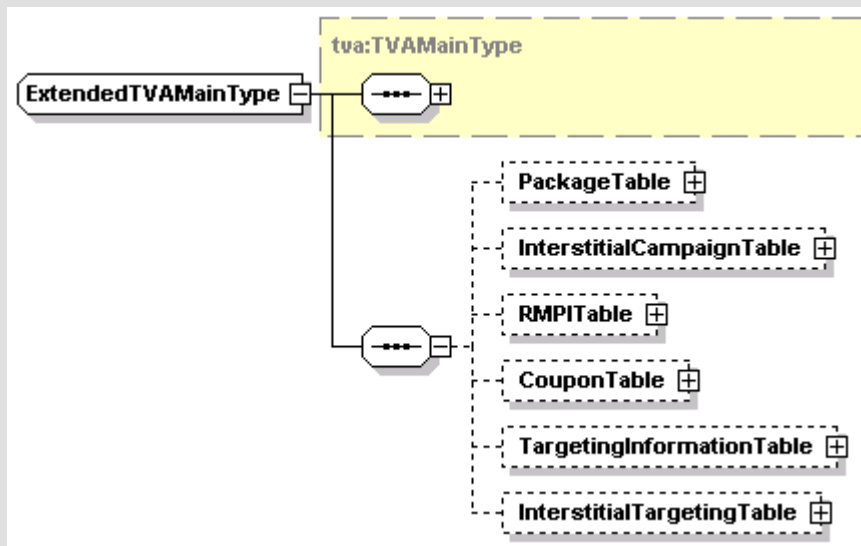

```
<complexType name="ExtendedTVAMainType">
  <complexContent>
    <extension base="tva:TVAMainType">
      <sequence>
        <element name="PackageTable" type="tva2:PackageTableType" minOccurs="0"/>
        <element name="InterstitialCampaignTable"
          type="tva2:InterstitialCampaignTableType" minOccurs="0"/>
        <element name="RMPITable" type="tva2:RMPITableType" minOccurs="0"/>
        <element name="CouponTable" type="tva2:CouponTableType" minOccurs="0"/>
        <element name="TargetingInformationTable"
          type="tva2:TargetingInformationTableType" minOccurs="0"/>
        <element name="InterstitialTargetingTable" type="int:TargetingTableType"
          minOccurs="0" />
      </sequence>
    </extension>
  </complexContent>
</complexType>
```

Name	Definition
ExtendedTVAMainType	Describes extended TVAMain.
PackageTable	A table containing Package descriptions.
InterstitialCampaignTable	A table containing Interstitial campaign information.
RMPITable	A table containing globally declared RMPI descriptions.
CouponTable	A table containing globally declared Coupon description.
TargetingInformationTable	A table containing globally declared Targeting Information.
InterstitialTargetingTable	A table containing Interstitial replacement information. A full description of the data type is provided in TS 102 822-3-4 [5].

Annex A (normative): TV-Anytime classification schemes

A.1 Introduction

The Classification Scheme DS is an MPEG-7 tool for the provision of controlled terminology for use in classification. It is defined in clause 7.3 of the ISO/IEC 15938-5 [16]. The MDS specification also shows how URNs can be used to uniquely identify CSs and terms within CSs, as well as the use of CS aliasing to provide a more concise, application-specific way of referring to classification terms.

An informative set of Classification Schemes has been developed by TVA to provide a universally applicable default set of classification terms. In addition to - or as a total or partial replacement for - these default CSs, implementers may create and make use of other CSs to meet specific regional or other special requirements (see clause B.3). These default CSs are presented as well-formed XML instance documents complying with the ClassificationScheme fragment defined in clause 4.3.1.13 of TS 102 822-3-2 [4]. These are not schema valid, which would require the incorporation of the fragment into an instance of ClassificationSchemeTable in the TVAMain document.

EXAMPLE 1:

```
<TVAMain xml:lang="en" xmlns="urn:tva:metadata:2011" xmlns:mpeg7="urn:tva:mpeg7:2008"
xmlns:xsi="http://www.w3.org/2001/XMLSchema-instance" xsi:schemaLocation="urn:tva:metadata:2012
tva_metadata_3-1_v181.xsd">
  <ClassificationSchemeTable>
    <ClassificationScheme uri="urn:tva:metadata:cs:ActionTypeCS:2010">
      <!-- ##### -->
      <!-- ACTIONTYPE -->
      <!-- Definition: Types of user action being
monitored to analyse viewing habits-->
      <!-- ##### -->
      <mpeg7:Term termID="1">
        <mpeg7:Name xml:lang="en">Audio-Video</mpeg7:Name>
        <mpeg7:Definition xml:lang="en">Actions Related to Audio and
Video</mpeg7:Definition>
      </mpeg7:Term>
      <!--etc.-->
    </ClassificationScheme>
  </ClassificationSchemeTable>
</TVAMain>
```

The syntax for naming default TVA CSs is closely modelled on that used for MPEG-7 CSs and takes the form:

- "urn:tva:metadata:cs:*SchemeName*".

The first four structural components, which always take the form "urn:tva:metadata:cs", indicate that a CS is being named within the TVA metadata CS namespace. The terminating component, *SchemeName*, uniquely names the CS within the namespace, e.g. "urn:tva:metadata:cs:IntentionCS". In addition, the *SchemeName* may, if required, include one or more version qualifiers separated from the name by a colon, e.g. "urn:tva:metadata:cs:IntentionCS:2005".

However, it is recognized that alternative forms of a URI (e.g. a URL) are equally valid to uniquely identify classification schemes other than presented in the present document.

Examples of the use of the different forms of pointers to classification schemes and associated aliases are provided in clause 7.4.4.5.2 of the ISO/IEC 15938-5 [16]. It is to be noted that in the case of URNs, the separator to be used is the ":", while it is the "#" in the case of URLs.

- EXAMPLE 2: If "S1" is the alias for "urn:tva:metadata:cs:IntentionCS:2004", then a termID will be accessed through ":S1:1.2.3.4" and the fully qualified term path is: "urn:tva:metadata:cs:IntentionCS:2004:1.2.3.4".

If "S2" is the alias for "http://arib.or.jp/tv-anytime/ContentCS.xml", then a termID will be accessed through ":S2:1.2.3.4" and the fully qualified term path is: "http://arib.or.jp/tv-anytime/ContentCS.xml#1.2.3.4".

If external Classification Schemes are used, it is an important implementation requirement to ensure that these resources are accessible by the metadata recipient. In the case of a URL, it shall be ensured that the presence of the file is maintained at the declared location. In the case of a URN, the actual scheme location shall be provided for interoperability purposes.

In complement to the Phase 1 Classification Schemes defined in TS 102 822-3-1 [3], an informative set of Phase 2 Classification Schemes has been developed by TVA to provide a universally applicable default set of classification terms.

A.2 Game Perspectives CS

The GamePerspectivesCS defines a controlled set of terms for the classification of games content considered from the perspective of players.

```
<?xml version="1.0" encoding="UTF-8"?>
<ClassificationScheme uri="urn:tva:metadata:extended:cs:GamePerspectivesCS:2011">
  <Term termID="1">
    <Name xml:lang="en">First-Person</Name>
    <Definition xml:lang="en">
      Displayed from a 1st-person perspective or view; i.e. from the viewer's own eyes.
    </Definition>
  </Term>
  <Term termID="2">
    <Name xml:lang="en">Third-Person</Name>
    <Definition xml:lang="en">
      Displayed from a 3rd-person perspective or view; i.e. player is able to see him/herself.
    </Definition>
  </Term>
  <Term termID="3">
    <Name xml:lang="en">Top-Down</Name>
    <Definition xml:lang="en">
      Used to describe any game where the main setting of gameplay is represented by a "top-down"
      view of the playfield; used in describing both shooters and adventure games.
    </Definition>
  </Term>
  <Term termID="4">
    <Name xml:lang="en">Isometric</Name>
    <Definition xml:lang="en">
      Playfield is technically two-dimensional, but drawn in an isometric view so that the game
      looks three-dimensional.
    </Definition>
  </Term>
  <Term termID="5">
    <Name xml:lang="en">Flat, Side-View</Name>
    <Definition xml:lang="en">
      The flat, side-view is the traditional two-dimensional "side view" of the action.
    </Definition>
  <Term termID="5.1">
    <Name xml:lang="en">Side-scroller</Name>
    <Definition xml:lang="en">
      Used to describe any game where the main setting of gameplay involves the player moving
      from one side of the playfield to the other horizontally for a length of time.
    </Definition>
  </Term>
  <Term termID="5.2">
    <Name xml:lang="en">platform</Name>
    <Definition xml:lang="en">
      Describes any action game where the playfield is set up as a series of floors, levels,
      or platforms for the player to navigate.
    </Definition>
  </Term>
  <Term termID="6">
    <Name xml:lang="en">Text-Based Game</Name>
    <Definition xml:lang="en">
      Describes text-based games that do not use graphics at or very sparingly.
    </Definition>
  </Term>
</ClassificationScheme>*
```

A.3 Intended Educational User CS

The IntendedEducationalUserCS defines a controlled set of terms for the classification of intended educational users of content.

```
<?xml version="1.0" encoding="UTF-8"?>
<ClassificationScheme uri="urn:tva:metadata:extended:cs:IntendedEducationalUserCS:2011">
  <Term termID="1">
    <Name xml:lang="en">Teachers</Name>
  </Term>
  <Term termID="2">
    <Name xml:lang="en">Managers</Name>
  </Term>
  <Term termID="3">
    <Name xml:lang="en">Special learners</Name>
  </Term>
  <Term termID="4">
    <Name xml:lang="en">General</Name>
  </Term>
  <Term termID="5">
    <Name xml:lang="en">Beginner</Name>
  </Term>
</ClassificationScheme>
```

A.4 Educational Use CS

The EducationalUseCS defines a controlled set of terms for the classification of educational uses of content.

```
<?xml version="1.0" encoding="UTF-8"?>
<ClassificationScheme uri="urn:tva:metadata:extended:cs:EducationalUseCS:2005">
  <Term termID="1">
    <Name xml:lang="en">Exercise</Name>
  </Term>
  <Term termID="2">
    <Name xml:lang="en">Animation</Name>
  </Term>
  <Term termID="3">
    <Name xml:lang="en">Exam</Name>
  </Term>
  <Term termID="4">
    <Name xml:lang="en">Narrative text</Name>
  </Term>
  <Term termID="5">
    <Name xml:lang="en">Experiment</Name>
  </Term>
  <Term termID="6">
    <Name xml:lang="en">Exercise</Name>
  </Term>
  <Term termID="7">
    <Name xml:lang="en">Self-assessment</Name>
  </Term>
  <Term termID="8">
    <Name xml:lang="en">Lecture</Name>
  </Term>
</ClassificationScheme>
```

A.5 Family Member CS

The FamilyMemberCS defines a controlled set of terms for the classification of family members in the household of the content user.

```
<?xml version="1.0" encoding="UTF-8"?>
<ClassificationScheme uri="urn:tva:metadata:extended:cs:FamilyMemberCS:2005">
  <Term termID="1">
    <Name xml:lang="en">Mother</Name>
    <Term termID="1.1">
      <Name xml:lang="en">Step-mother</Name>
    </Term>
    <Term termID="1.2">
      <Name xml:lang="en">Mother-in-law</Name>
    </Term>
  </Term>
  <Term termID="2">
    <Name xml:lang="en">Father</Name>
    <Term termID="2.1">
      <Name xml:lang="en">Step-father</Name>
    </Term>
    <Term termID="2.2">
      <Name xml:lang="en">Father-in-law</Name>
    </Term>
  </Term>
  <Term termID="3">
    <Name xml:lang="en">Grandmother</Name>
  </Term>
  <Term termID="4">
    <Name xml:lang="en">Grandfather</Name>
  </Term>
  <Term termID="5">
    <Name xml:lang="en">Great-grandmother</Name>
  </Term>
  <Term termID="6">
    <Name xml:lang="en">Great-grandfather</Name>
  </Term>
  <Term termID="7">
    <Name xml:lang="en">Great-great-grandmother</Name>
  </Term>
  <Term termID="8">
    <Name xml:lang="en">Great-great-grandfather</Name>
  </Term>
  <Term termID="9">
    <Name xml:lang="en">Sibling</Name>
    <Term termID="9.1">
      <Name xml:lang="en">Brother</Name>
      <Term termID="9.1.1">
        <Name xml:lang="en">Half-brother</Name>
        <Term termID="9.1.1.1">
          <Name xml:lang="en">Younger half-brother</Name>
        </Term>
        <Term termID="9.1.1.2">
          <Name xml:lang="en">Elder half-brother</Name>
        </Term>
      </Term>
      <Term termID="9.1.2">
        <Name xml:lang="en">Step-brother</Name>
        <Term termID="9.1.2.1">
          <Name xml:lang="en">Younger step-brother</Name>
        </Term>
        <Term termID="9.1.2.2">
          <Name xml:lang="en">Elder step-brother</Name>
        </Term>
      </Term>
      <Term termID="9.1.3">
        <Name xml:lang="en">Brother-in-law</Name>
        <Term termID="9.1.3.1">
          <Name xml:lang="en">Younger brother-in-law</Name>
        </Term>
        <Term termID="9.1.3.2">
          <Name xml:lang="en">Elder brother-in-law</Name>
        </Term>
      </Term>
      <Term termID="9.1.4">
        <Name xml:lang="en">Twin brother</Name>
      </Term>
    </Term>
  </Term>

```

```

    </Term>
  </Term>
  <Term termID="9.2">
    <Name xml:lang="en">Sister</Name>
    <Term termID="9.2.1">
      <Name xml:lang="en">Half-sister</Name>
      <Term termID="9.2.1.1">
        <Name xml:lang="en">Younger half-sister</Name>
      </Term>
      <Term termID="9.2.1.2">
        <Name xml:lang="en">Elder half-sister</Name>
      </Term>
    </Term>
    <Term termID="9.2.2">
      <Name xml:lang="en">Step-sister</Name>
      <Term termID="9.2.2.1">
        <Name xml:lang="en">Younger step-sister</Name>
      </Term>
      <Term termID="9.2.2.2">
        <Name xml:lang="en">Elder step-sister</Name>
      </Term>
    </Term>
    <Term termID="9.2.3">
      <Name xml:lang="en">Sister-in-law</Name>
      <Term termID="9.2.2.1">
        <Name xml:lang="en">Younger sister-in-law</Name>
      </Term>
      <Term termID="9.2.2.2">
        <Name xml:lang="en">Elder sister-in-law</Name>
      </Term>
    </Term>
    <Term termID="9.2.4">
      <Name xml:lang="en">Twin sister</Name>
    </Term>
  </Term>
</Term>
<Term termID="10">
  <Name xml:lang="en">Twin</Name>
</Term>
<Term termID="11">
  <Name xml:lang="en">Cousin</Name>
  <Term termID="11.1">
    <Name xml:lang="en">First cousin</Name>
    <Term termID="11.1.1">
      <Name xml:lang="en">First cousin once removed</Name>
    </Term>
    <Term termID="11.1.2">
      <Name xml:lang="en">First cousin twice removed</Name>
    </Term>
    <Term termID="11.1.3">
      <Name xml:lang="en">First cousin three times removed</Name>
    </Term>
  </Term>
  <Term termID="11.2">
    <Name xml:lang="en">Second cousin</Name>
    <Term termID="11.2.1">
      <Name xml:lang="en">Second cousin once removed</Name>
    </Term>
    <Term termID="11.2.2">
      <Name xml:lang="en">Second cousin twice removed</Name>
    </Term>
    <Term termID="11.2.3">
      <Name xml:lang="en">Second cousin three times removed</Name>
    </Term>
  </Term>
  <Term termID="11.3">
    <Name xml:lang="en">Third cousin</Name>
    <Term termID="11.3.1">
      <Name xml:lang="en">Third cousin once removed</Name>
    </Term>
    <Term termID="11.3.2">
      <Name xml:lang="en">Third cousin twice removed</Name>
    </Term>
    <Term termID="11.3.3">
      <Name xml:lang="en">Third cousin three times removed</Name>
    </Term>
  </Term>
</Term>
</Term>

```

```

<Term termID="12">
  <Name xml:lang="en">Wife</Name>
  <Term termID="12.1">
    <Name xml:lang="en">First wife</Name>
  </Term>
  <Term termID="12.2">
    <Name xml:lang="en">Second wife</Name>
  </Term>
  <Term termID="12.3">
    <Name xml:lang="en">Third wife</Name>
  </Term>
</Term>
<Term termID="13">
  <Name xml:lang="en">Husband</Name>
  <Term termID="13.1">
    <Name xml:lang="en">First husband</Name>
  </Term>
  <Term termID="13.2">
    <Name xml:lang="en">Second husband</Name>
  </Term>
  <Term termID="13.3">
    <Name xml:lang="en">Third husband</Name>
  </Term>
</Term>
<Term termID="14">
  <Name xml:lang="en">Spouse</Name>
</Term>
<Term termID="15">
  <Name xml:lang="en">Ex-wife</Name>
</Term>
<Term termID="16">
  <Name xml:lang="en">Ex-husband</Name>
</Term>
<Term termID="17">
  <Name xml:lang="en">Uncle</Name>
</Term>
<Term termID="18">
  <Name xml:lang="en">Aunt</Name>
</Term>
<Term termID="19">
  <Name xml:lang="en">Great uncle</Name>
</Term>
<Term termID="20">
  <Name xml:lang="en">Great aunt</Name>
</Term>
<Term termID="21">
  <Name xml:lang="en">Great great uncle</Name>
</Term>
<Term termID="22">
  <Name xml:lang="en">Great great aunt</Name>
</Term>
<Term termID="23">
  <Name xml:lang="en">Daughter</Name>
  <Term termID="23.1">
    <Name xml:lang="en">Step daughter</Name>
  </Term>
  <Term termID="23.2">
    <Name xml:lang="en">Daughter-in-law</Name>
  </Term>
  <Term termID="23.3">
    <Name xml:lang="en">God-daughter</Name>
  </Term>
</Term>
<Term termID="24">
  <Name xml:lang="en">Son</Name>
  <Term termID="24.1">
    <Name xml:lang="en">Step son</Name>
  </Term>
  <Term termID="24.2">
    <Name xml:lang="en">Son-in-law</Name>
  </Term>
  <Term termID="24.3">
    <Name xml:lang="en">God son</Name>
  </Term>
</Term>
<Term termID="25">
  <Name xml:lang="en">Grand-daughter</Name>
  <Term termID="25.1">

```



```

    <Name xml:lang="en">Step grand-daughter</Name>
  </Term>
</Term>
<Term termID="26">
  <Name xml:lang="en">Grandson</Name>
  <Term termID="26.1">
    <Name xml:lang="en">Step grandson</Name>
  </Term>
</Term>
<Term termID="27">
  <Name xml:lang="en">Great grand-daughter</Name>
</Term>
<Term termID="28">
  <Name xml:lang="en">Great grandson</Name>
</Term>
<Term termID="29">
  <Name xml:lang="en">Great great grand-daughter</Name>
</Term>
<Term termID="30">
  <Name xml:lang="en">Great great grandson</Name>
</Term>
<Term termID="31">
  <Name xml:lang="en">Nephew</Name>
</Term>
<Term termID="32">
  <Name xml:lang="en">Niece</Name>
</Term>
</ClassificationScheme>

```

A.6 Accessibility CS

The AccessibilityCS defines a controlled set of terms for the classification of the accessibility characteristics of a content user.

```

<?xml version="1.0" encoding="UTF-8"?>
<ClassificationScheme uri="urn:tva:metadata:extended:cs:AccessibilityCS:2005">
  <Term termID="AbleToUseRemote">
    <Name xml:lang="en">Able to use remote</Name>
  </Term>
  <Term termID="UnableToUseRemote">
    <Name xml:lang="en">Unable to use remote control</Name>
  </Term>
  <Term termID="AbleToUseKeyboard">
    <Name xml:lang="en">Able to use keyboard</Name>
  </Term>
  <Term termID="UnableToUseKeyboard">
    <Name xml:lang="en">Unable to use keyboard</Name>
  </Term>
  <Term termID="AbleToUsePointingDevice">
    <Name xml:lang="en">Able to use pointing device</Name>
  </Term>
  <Term termID="UnableToUsePointingDevice">
    <Name xml:lang="en">Unable to use pointing device</Name>
  </Term>
  <Term termID="VoiceOnly">
    <Name xml:lang="en">Voice interaction only</Name>
  </Term>
</ClassificationScheme>

```

A.7 CPU Type CS

The CPUTypeCS defines a controlled set of terms for the classification of CPUs of user equipment.

```
<?xml version="1.0" encoding="UTF-8"?>
<ClassificationScheme uri="urn:tva:metadata:extended:cs:CPUTypeCS:2005">
  <Term termID="1">
    <Name xml:lang="en">CPU for PC</Name>
    <Term termID="1.1">
      <Name xml:lang="en">Intel</Name>
      <Term termID="1.1.1">
        <Name xml:lang="en">4004</Name>
      </Term>
      <Term termID="1.1.2">
        <Name xml:lang="en">8008</Name>
      </Term>
      <Term termID="1.1.3">
        <Name xml:lang="en">8080</Name>
      </Term>
      <Term termID="1.1.4">
        <Name xml:lang="en">8086</Name>
      </Term>
      <Term termID="1.1.5">
        <Name xml:lang="en">8088</Name>
      </Term>
      <Term termID="1.1.6">
        <Name xml:lang="en">(80)286</Name>
      </Term>
      <Term termID="1.1.7">
        <Name xml:lang="en">(80)386</Name>
      </Term>
      <Term termID="1.1.8">
        <Name xml:lang="en">(80)486</Name>
      </Term>
      <Term termID="1.1.9">
        <Name xml:lang="en">Pentium</Name>
      </Term>
      <Term termID="1.1.10">
        <Name xml:lang="en">Pentium Pro</Name>
      </Term>
      <Term termID="1.1.11">
        <Name xml:lang="en">Pentium MMX</Name>
      </Term>
      <Term termID="1.1.12">
        <Name xml:lang="en">Pentium II</Name>
      </Term>
      <Term termID="1.1.13">
        <Name xml:lang="en">Celeron</Name>
        <Term termID="1.1.13.1">
          <Name xml:lang="en">Celeron Northwood</Name>
        </Term>
        <Term termID="1.1.13.2">
          <Name xml:lang="en">CeleronD Prescott</Name>
        </Term>
      </Term>
      <Term termID="1.1.14">
        <Name xml:lang="en">Xeon</Name>
      </Term>
      <Term termID="1.1.15">
        <Name xml:lang="en">Itanium</Name>
      </Term>
      <Term termID="1.1.16">
        <Name xml:lang="en">Pentium IV</Name>
        <Term termID="1.1.16.1">
          <Name xml:lang="en">Pentium IV Northwood</Name>
        </Term>
        <Term termID="1.1.16.2">
          <Name xml:lang="en">Pentium IV Willamette</Name>
        </Term>
        <Term termID="1.1.16.2">
          <Name xml:lang="en">Pentium IV Prescott</Name>
        </Term>
      </Term>
      <Term termID="1.1.17">
        <Name xml:lang="en">McKinley</Name>
      </Term>
    </Term>
  </Term>
</ClassificationScheme>
```

```

    <Term termID="1.1.18">
      <Name xml:lang="en">Deerfield</Name>
    </Term>
  </Term>
</Term>
<Term termID="1.2">
  <Name xml:lang="en">AMD</Name>
  <Term termID="1.2.1">
    <Name xml:lang="en">K5</Name>
  </Term>
  <Term termID="1.2.2">
    <Name xml:lang="en">K6</Name>
  </Term>
  <Term termID="1.2.3">
    <Name xml:lang="en">K6-2</Name>
  </Term>
  <Term termID="1.2.4">
    <Name xml:lang="en">K6-3</Name>
  </Term>
  <Term termID="1.2.5">
    <Name xml:lang="en">Duron</Name>
  </Term>
  <Term termID="1.2.6">
    <Name xml:lang="en">Sempron</Name>
    <Term termID="1.2.6.1">
      <Name xml:lang="en">Sempron ThoroughbredB</Name>
    </Term>
    <Term termID="1.2.6.2">
      <Name xml:lang="en">Sempron Paris</Name>
    </Term>
    <Term termID="1.2.6.3">
      <Name xml:lang="en">Sempron Palermo</Name>
    </Term>
  </Term>
  <Term termID="1.2.7">
    <Name xml:lang="en">Athlon Professional Ultra</Name>
    <Term termID="1.2.7.1">
      <Name xml:lang="en">Athlon 64</Name>
      <Term termID="1.2.7.1.1">
        <Name xml:lang="en">Athlon 64 NewCastle</Name>
      </Term>
      <Term termID="1.2.7.1.2">
        <Name xml:lang="en">Athlon 64 Winchester</Name>
      </Term>
      <Term termID="1.2.7.1.3">
        <Name xml:lang="en">Athlon 64 Claw-Hammer</Name>
      </Term>
      <Term termID="1.2.7.1.4">
        <Name xml:lang="en">Athlon 64 FX 55 Claw-Hammer</Name>
      </Term>
    </Term>
    <Term termID="1.2.7.2">
      <Name xml:lang="en">AthlonXP</Name>
      <Term termID="1.2.7.2.1">
        <Name xml:lang="en">AthlonXP Barton</Name>
      </Term>
      <Term termID="1.2.7.2.2">
        <Name xml:lang="en">AthlonXP M Barton</Name>
      </Term>
    </Term>
  </Term>
  <Term termID="1.2.8">
    <Name xml:lang="en">Opteron Sledge-Hammer</Name>
  </Term>
  <Term termID="1.2.9">
    <Name xml:lang="en">K8 </Name>
  </Term>
</Term>
<Term termID="1.3">
  <Name xml:lang="en">VIA</Name>
  <Term termID="3.1">
    <Name xml:lang="en">VIA C3 Nehemiah</Name>
  </Term>
</Term>
</Term>
<Term termID="2">
  <Name xml:lang="en">CPU for PDA</Name>
  <Term termID="2.1">
    <Name xml:lang="en">Motorola</Name>
  </Term>
</Term>

```

```

    <Term termID="2.1.1">
      <Name xml:lang="en">Dragonball</Name>
    </Term>
  </Term>
  <Term termID="2.2">
    <Name xml:lang="en">Hitachi</Name>
    <Term termID="2.2.1">
      <Name xml:lang="en">SH</Name>
    </Term>
  </Term>
  <Term termID="2.3">
    <Name xml:lang="en">NEC</Name>
    <Term termID="2.3.1">
      <Name xml:lang="en">VR</Name>
    </Term>
  </Term>
  <Term termID="2.4">
    <Name xml:lang="en">Intel</Name>
    <Term termID="2.4.1">
      <Name xml:lang="en">StrongARM</Name>
    </Term>
  </Term>
</Term>
<Term termID="3">
  <Name xml:lang="en">CPU for Settop</Name>
  <Term termID="3.1">
    <Name xml:lang="en">ATI</Name>
    <Term termID="3.1.1">
      <Name xml:lang="en">XILLEON</Name>
    </Term>
  </Term>
  <Term termID="3.2">
    <Name xml:lang="en">Zoran</Name>
    <Term termID="3.2.1">
      <Name xml:lang="en">Elite (G9) </Name>
    </Term>
  </Term>
  <Term termID="3.3">
    <Name xml:lang="en">Philips</Name>
    <Term termID="3.3.1">
      <Name xml:lang="en">SA7219</Name>
    </Term>
    <Term termID="3.3.2">
      <Name xml:lang="en">SA7240</Name>
    </Term>
  </Term>
</Term>
</ClassificationScheme>

```

A.8 Operating system CS

The following classification scheme defines a controlled set of terms for the classification of operating systems of user equipment.

```

<?xml version="1.0" encoding="UTF-8"?>
<ClassificationScheme uri="urn:tva:metadata:extended:cs:OperatingSystemCS:2007">
  <Term termID="1">
    <Name xml:lang="en">DOS</Name>
  </Term>
  <Term termID="2">
    <Name xml:lang="en">Windows</Name>
    <Term termID="2.1">
      <Name xml:lang="en">Windows 3.X</Name>
    </Term>
    <Term termID="2.2">
      <Name xml:lang="en">Windows 95</Name>
    </Term>
    <Term termID="2.3">
      <Name xml:lang="en">Windows 98</Name>
    </Term>
    <Term termID="2.4">
      <Name xml:lang="en">Windows Me</Name>
    </Term>
  </Term>

```

```

<Term termID="2.5">
  <Name xml:lang="en">Windows NT</Name>
</Term>
<Term termID="2.6">
  <Name xml:lang="en">Windows 2000</Name>
</Term>
<Term termID="2.7">
  <Name xml:lang="en">Windows 2003 Server</Name>
</Term>
<Term termID="2.8">
  <Name xml:lang="en">Windows XP</Name>
</Term>
<Term termID="2.9">
  <Name xml:lang="en">Windows VISTA</Name>
</Term>
</Term>
<Term termID="3">
  <Name xml:lang="en">Linux</Name>
</Term>
<Term termID="4">
  <Name xml:lang="en">Unix</Name>
</Term>
<Term termID="5">
  <Name xml:lang="en">Solaris</Name>
</Term>
<Term termID="6">
  <Name xml:lang="en">OS2</Name>
</Term>
<Term termID="7">
  <Name xml:lang="en">Mac</Name>
  <Term termID="7.1">
    <Name xml:lang="en">System 6</Name>
  </Term>
  <Term termID="7.2">
    <Name xml:lang="en">System 7</Name>
  </Term>
  <Term termID="7.3">
    <Name xml:lang="en">Mac OS 7.x</Name>
  </Term>
  <Term termID="7.4">
    <Name xml:lang="en">Mac OS 8.x</Name>
  </Term>
  <Term termID="7.5">
    <Name xml:lang="en">Mac OS 9.x</Name>
  </Term>
  <Term termID="7.6">
    <Name xml:lang="en">Mac OS X</Name>
  </Term>
  <Term termID="7.7">
    <Name xml:lang="en">Mac OS X Server</Name>
  </Term>
</Term>
<Term termID="8">
  <Name xml:lang="en">Mobile</Name>
  <Term termID="8.1">
    <Name xml:lang="en">Palm OS 1.x</Name>
  </Term>
  <Term termID="8.2">
    <Name xml:lang="en">Palm OS 2.x</Name>
  </Term>
  <Term termID="8.3">
    <Name xml:lang="en">Palm OS 3.x</Name>
  </Term>
  <Term termID="8.4">
    <Name xml:lang="en">Palm OS 4.x</Name>
  </Term>
  <Term termID="8.5">
    <Name xml:lang="en">Palm OS 5.x</Name>
  </Term>
  <Term termID="8.6">
    <Name xml:lang="en">Windows CE 1.x</Name>
  </Term>
  <Term termID="8.7">
    <Name xml:lang="en">Windows CE 2.x</Name>
  </Term>
  <Term termID="8.8">
    <Name xml:lang="en">Pocket PC</Name>
  </Term>

```

```

<Term termID="8.9">
  <Name xml:lang="en">Pocket PC 2002</Name>
</Term>
<Term termID="8.10">
  <Name xml:lang="en">Pocket PC 2003</Name>
</Term>
<Term termID="8.11">
  <Name xml:lang="en">Celvic OS</Name>
</Term>
<Term termID="8.12">
  <Name xml:lang="en">EPOC (Psion OS)</Name>
</Term>
<Term termID="8.13">
  <Name xml:lang="en">Symbian</Name>
</Term>
<Term termID="8.14">
  <Name xml:lang="en">Windows Mobile 2003 Phone Edition</Name>
</Term>
</Term>
<Term termID="9">
  <Name xml:lang="en">Embedded OS</Name>
  <Term termID="9.1">
    <Name xml:lang="en">Windows CE</Name>
  </Term>
  <Term termID="9.2">
    <Name xml:lang="en">Embedded Linux </Name>
  </Term>
  <Term termID="9.3">
    <Name xml:lang="en">Embedded Java</Name>
  </Term>
</Term>
<Term termID="10">
  <Name xml:lang="en">RTOS (Real Time OS)</Name>
  <Term termID="10.1">
    <Name xml:lang="en">pSOS</Name>
  </Term>
  <Term termID="10.2">
    <Name xml:lang="en">OS-9</Name>
  </Term>
  <Term termID="10.3">
    <Name xml:lang="en">VxWorks</Name>
  </Term>
  <Term termID="10.4">
    <Name xml:lang="en">QNX</Name>
  </Term>
  <Term termID="10.5">
    <Name xml:lang="en">VRTX</Name>
  </Term>
  <Term termID="10.6">
    <Name xml:lang="en">Nucleus</Name>
  </Term>
  <Term termID="10.7">
    <Name xml:lang="en">Qplus</Name>
  </Term>
  <Term termID="10.8">
    <Name xml:lang="en">Lynx</Name>
  </Term>
  <Term termID="10.9">
    <Name xml:lang="en">RT-Linux</Name>
  </Term>
</Term>
</ClassificationScheme>

```

A.9 Virtual Machine CS

The VirtualMachineCS defines a controlled set of terms for the classification of virtual machine software on equipment available to content users.

```
<?xml version="1.0" encoding="UTF-8"?>
<ClassificationScheme uri="urn:tva:metadata:extended:cs:VirtualMachineCS:2005">
  <Term termID="1">
    <Name xml:lang="en">Core War</Name>
  </Term>
  <Term termID="2">
    <Name xml:lang="en">Java VM</Name>
    <Term termID="2.1">
      <Name xml:lang="en">Platform</Name>
      <Term termID="2.1.1">
        <Name xml:lang="en">J2SE</Name>
      </Term>
      <Term termID="2.1.2">
        <Name xml:lang="en">J2EE</Name>
      </Term>
      <Term termID="2.1.3">
        <Name xml:lang="en">J2ME</Name>
      </Term>
    </Term>
    <Term termID="2.2">
      <Name xml:lang="en">Speed</Name>
      <Term termID="2.2.1">
        <Name xml:lang="en">Classic</Name>
      </Term>
      <Term termID="2.2.2">
        <Name xml:lang="en">Hotspot</Name>
      </Term>
    </Term>
    <Term termID="2.3">
      <Name xml:lang="en">For J2ME</Name>
      <Term termID="2.3.1">
        <Name xml:lang="en">KVM(Kilobyte VM)</Name>
      </Term>
      <Term termID="2.3.2">
        <Name xml:lang="en">GVM(Game VM)</Name>
      </Term>
      <Term termID="2.3.3">
        <Name xml:lang="en">MAP(Mobile Application S/W plug-in)</Name>
      </Term>
      <Term termID="2.3.4">
        <Name xml:lang="en">BREW</Name>
      </Term>
      <Term termID="2.3.5">
        <Name xml:lang="en">Redbook compliant VM</Name>
      </Term>
    </Term>
  </Term>
  <Term termID="3">
    <Name xml:lang="en">OCODE</Name>
  </Term>
  <Term termID="4">
    <Name xml:lang="en">OS/2</Name>
  </Term>
  <Term termID="5">
    <Name xml:lang="en">POPLOG</Name>
  </Term>
  <Term termID="6">
    <Name xml:lang="en">Portable Scheme Interpreter</Name>
  </Term>
  <Term termID="7">
    <Name xml:lang="en">Portable Standard Lisp</Name>
  </Term>
  <Term termID="8">
    <Name xml:lang="en">Parallel Virtual Machine</Name>
  </Term>
  <Term termID="9">
    <Name xml:lang="en">Sequential Parlog Machine</Name>
  </Term>
  <Term termID="10">
    <Name xml:lang="en">SNOBOL Implementation Language</Name>
  </Term>
</ClassificationScheme>
```

```

<Term termID="11">
  <Name xml:lang="en">SODA</Name>
</Term>
<Term termID="12">
  <Name xml:lang="en">Smalltalk</Name>
</Term>
</ClassificationScheme>

```

A.10 Other System Software CS

The OtherSystemSoftwareCS defines a controlled set of terms for the classification of system software, other than middleware and virtual machine software, on equipment available to content users.

```

<?xml version="1.0" encoding="UTF-8"?>
<ClassificationScheme uri="urn:tva:metadata:extended:cs:OtherSystemSoftwareCS:2005">
  <!-- #####-->
  <!--OtherSystemSoftwareCS -->
  <!--Definition: This is a set of terms used within Content Packaging to indicate -->
  <!-- what kind of system software are needed in the Terminal written by HeeKyung Lee -->
  <!-- #####-->
  <Term termID="1">
    <Name xml:lang="en">Graphic library</Name>
    <Term termID="1.1">
      <Name xml:lang="en">DirectX</Name>
      <Term termID="1.1.1">
        <Name xml:lang="en">DirectX8.0</Name>
      </Term>
      <Term termID="1.1.2">
        <Name xml:lang="en">DirectX8.1</Name>
      </Term>
      <Term termID="1.1.3">
        <Name xml:lang="en">DirectX9.0</Name>
      </Term>
    </Term>
    <Term termID="1.2">
      <Name xml:lang="en">OpenGL</Name>
    </Term>
  </Term>
  <Term termID="2">
    <Name xml:lang="en">Media</Name>
    <Term termID="2.1">
      <Name xml:lang="en">mpeg-1 codec</Name>
    </Term>
    <Term termID="2.2">
      <Name xml:lang="en">mpeg-2 codec</Name>
    </Term>
    <Term termID="2.3">
      <Name xml:lang="en">real audio codec</Name>
    </Term>
    <Term termID="2.4">
      <Name xml:lang="en">quicktime format codec</Name>
    </Term>
    <Term termID="2.5">
      <Name xml:lang="en">windows media player</Name>
    </Term>
    <Term termID="2.6">
      <Name xml:lang="en">flash</Name>
    </Term>
  </Term>
  <Term termID="3">
    <Name xml:lang="en">DB</Name>
    <Term termID="3.1">
      <Name xml:lang="en">JDBC</Name>
    </Term>
    <Term termID="3.2">
      <Name xml:lang="en">Firebird/InterBase</Name>
    </Term>
    <Term termID="3.3">
      <Name xml:lang="en">Microsoft SQL Server</Name>
    </Term>
    <Term termID="3.4">
      <Name xml:lang="en">MySQL</Name>
    </Term>
  </Term>

```



```

<Term termID="3.5">
  <Name xml:lang="en">Oracle</Name>
</Term>
<Term termID="3.6">
  <Name xml:lang="en">Other network-based DBMS</Name>
</Term>
<Term termID="3.7">
  <Name xml:lang="en">PostgreSQL</Name>
</Term>
</Term>
<Term termID="4">
  <Name xml:lang="en">GUI Library</Name>
  <Term termID="4.1">
    <Name xml:lang="en">Amulet</Name>
  </Term>
  <Term termID="4.2">
    <Name xml:lang="en">FLTK</Name>
  </Term>
  <Term termID="4.3">
    <Name xml:lang="en">GTK</Name>
  </Term>
  <Term termID="4.4">
    <Name xml:lang="en">MFC</Name>
  </Term>
  <Term termID="4.5">
    <Name xml:lang="en">Morphic</Name>
  </Term>
  <Term termID="4.6">
    <Name xml:lang="en">Motif</Name>
  </Term>
  <Term termID="4.7">
    <Name xml:lang="en">Python</Name>
  </Term>
  <Term termID="4.8">
    <Name xml:lang="en">Qt</Name>
  </Term>
  <Term termID="4.9">
    <Name xml:lang="en">wxWindows </Name>
  </Term>
</Term>
<Term termID="5">
  <Name xml:lang="en">Mobile</Name>
  <Term termID="5.1">
    <Name xml:lang="en">ActiveSync</Name>
  </Term>
  <Term termID="5.2">
    <Name xml:lang="en">.Net Framework</Name>
  </Term>
  <Term termID="5.3">
    <Name xml:lang="en">DioPen V5.0</Name>
  </Term>
</Term>
</ClassificationScheme>

```

A.11 Middleware Service CS

The following classification scheme defines a controlled set of terms for the Middleware element of SystemInformationType.

```

<?xml version="1.0" encoding="UTF-8"?>
<ClassificationScheme uri="urn:tva:metadata:extended:cs:MiddlewareServiceCS:2011">
  <Term termID="ACAP">
    <Name xml:lang="en">ACAP</Name>
  </Term>
  <Term termID="MHP">
    <Name xml:lang="en">MHP</Name>
  </Term>
  <Term termID="OCAP">
    <Name xml:lang="en">OCAP</Name>
  </Term>
  <Term termID="BML">
    <Name xml:lang="en">BML</Name>
  </Term>
</ClassificationScheme>

```

```

<Term termID="MHEG-5">
  <Name xml:lang="en">MHEG-5</Name>
</Term>
<Term termID="Open-TV">
  <Name xml:lang="en">Open-TV</Name>
</Term>
<Term termID="MediaHighway">
  <Name xml:lang="en">MediaHighway</Name>
</Term>
</ClassificationScheme>

```

A.12 Terminal Type CS

The following classification scheme defines a controlled set of terms for the classification of terminals available to content users.

```

<?xml version="1.0" encoding="UTF-8"?>
<ClassificationScheme uri="urn:tva:metadata:extended:cs:TerminalTypeCS:2011" >
  <Term termID="1">
    <Name xml:lang="en">PC</Name>
  </Term>
  <Term termID="2">
    <Name xml:lang="en">PDA</Name>
  </Term>
  <Term termID="3">
    <Name xml:lang="en">Set-Top Box</Name>
  <Term termID="3.1">
    <Name xml:lang="en">PDR</Name>
  </Term>
  <Term termID="3.2">
    <Name xml:lang="en">NDR</Name>
  </Term>
  <Term termID="3.3">
    <Name xml:lang="en">Cable Set-Top Box</Name>
  </Term>
  <Term termID="3.4">
    <Name xml:lang="en">Other Set-Top Box</Name>
  </Term>
</Term>
  <Term termID="4">
    <Name xml:lang="en">Printer</Name>
  </Term>
  <Term termID="5">
    <Name xml:lang="en">Mobile Phone</Name>
  </Term>
  <Term termID="6">
    <Name xml:lang="en">Digital Still Camera</Name>
  </Term>
  <Term termID="7">
    <Name xml:lang="en">Digital Video Camera</Name>
  </Term>
  <Term termID="8">
    <Name xml:lang="en">Audio Player</Name>
  </Term>
  <Term termID="9">
    <Name xml:lang="en">Television</Name>
  </Term>
  <Term termID="10">
    <Name xml:lang="en">Gateway</Name>
  </Term>
  <Term termID="11">
    <Name xml:lang="en">Router</Name>
  </Term>
  <Term termID="12">
    <Name xml:lang="en">Car Terminal</Name>
  <Term termID="12.1">
    <Name xml:lang="en">Car Stereo</Name>
  </Term>
  <Term termID="12.2">
    <Name xml:lang="en">Car Navigation</Name>
  </Term>
  <Term termID="12.3">
    <Name xml:lang="en">Car AV</Name>
  </Term>

```

```

    </Term>
  </Term>
  <Term termID="13">
    <Name xml:lang="en">Game Platform</Name>
    <Term termID="13.1">
      <Name xml:lang="en">3DO</Name>
    </Term>
    <Term termID="13.2">
      <Name xml:lang="en">Amiga</Name>
    </Term>
    <Term termID="13.3">
      <Name xml:lang="en">Apple II</Name>
    </Term>
    <Term termID="13.4">
      <Name xml:lang="en">Atari</Name>
      <Term termID="13.4.1">
        <Name xml:lang="en">2600</Name>
      </Term>
      <Term termID="13.4.2">
        <Name xml:lang="en">5200</Name>
      </Term>
      <Term termID="13.4.3">
        <Name xml:lang="en">7800</Name>
      </Term>
      <Term termID="13.4.4">
        <Name xml:lang="en">ST</Name>
      </Term>
    </Term>
    <Term termID="13.5">
      <Name xml:lang="en">ColecoVision</Name>
    </Term>
    <Term termID="13.6">
      <Name xml:lang="en">Commodore 64</Name>
    </Term>
    <Term termID="13.7">
      <Name xml:lang="en">Dreamcast</Name>
    </Term>
    <Term termID="13.8">
      <Name xml:lang="en">Game Boy</Name>
      <Term termID="13.8.1">
        <Name xml:lang="en">Usual</Name>
      </Term>
      <Term termID="13.8.2">
        <Name xml:lang="en">Advance</Name>
      </Term>
      <Term termID="13.8.3">
        <Name xml:lang="en">Color</Name>
      </Term>
    </Term>
    <Term termID="13.9">
      <Name xml:lang="en">Game Cube</Name>
    </Term>
    <Term termID="13.10">
      <Name xml:lang="en">Game Gear</Name>
    </Term>
    <Term termID="13.11">
      <Name xml:lang="en">Genesis</Name>
    </Term>
    <Term termID="13.12">
      <Name xml:lang="en">Intellivision</Name>
    </Term>
    <Term termID="13.13">
      <Name xml:lang="en">Jaguar</Name>
    </Term>
    <Term termID="13.14">
      <Name xml:lang="en">Lynx</Name>
    </Term>
    <Term termID="13.15">
      <Name xml:lang="en">NES</Name>
    </Term>
    <Term termID="13.16">
      <Name xml:lang="en">N-Gage</Name>
    </Term>
    <Term termID="13.17">
      <Name xml:lang="en">Nintendo</Name>
      <Term termID="13.17.1">
        <Name xml:lang="en">64</Name>
      </Term>
    </Term>
  </Term>

```

```

    <Term termID="13.17.2">
      <Name xml:lang="en">DS</Name>
    </Term>
  </Term>
  <Term termID="13.18">
    <Name xml:lang="en">PC Booter</Name>
  </Term>
  <Term termID="13.19">
    <Name xml:lang="en">PlayStation</Name>
    <Term termID="13.19.1">
      <Name xml:lang="en">Usual</Name>
    </Term>
    <Term termID="13.19.2">
      <Name xml:lang="en">2</Name>
    </Term>
  </Term>
  <Term termID="13.20">
    <Name xml:lang="en">PSP</Name>
  </Term>
  <Term termID="13.21">
    <Name xml:lang="en">Saturn</Name>
  </Term>
  <Term termID="13.22">
    <Name xml:lang="en">Sega</Name>
    <Term termID="13.22.1">
      <Name xml:lang="en">32X</Name>
    </Term>
    <Term termID="13.22.2">
      <Name xml:lang="en">CD</Name>
    </Term>
    <Term termID="13.22.3">
      <Name xml:lang="en">Master System</Name>
    </Term>
  </Term>
  <Term termID="13.23">
    <Name xml:lang="en">SNES</Name>
  </Term>
  <Term termID="13.24">
    <Name xml:lang="en">TI-99/4A</Name>
  </Term>
  <Term termID="13.25">
    <Name xml:lang="en">TurboGrafx</Name>
    <Term termID="13.25.1">
      <Name xml:lang="en">16</Name>
    </Term>
    <Term termID="13.25.2">
      <Name xml:lang="en">CD</Name>
    </Term>
  </Term>
  <Term termID="13.26">
    <Name xml:lang="en">Vectrex</Name>
  </Term>
  <Term termID="13.27">
    <Name xml:lang="en">VIC-20</Name>
  </Term>
  <Term termID="13.28">
    <Name xml:lang="en">Virtual Boy</Name>
  </Term>
  <Term termID="13.29">
    <Name xml:lang="en">V.Smile</Name>
  </Term>
  <Term termID="13.30">
    <Name xml:lang="en">Xbox</Name>
  </Term>
  <Term termID="13.31">
    <Name xml:lang="en">ZX Spectrum</Name>
  </Term>
</Term>
<Term termID="14">
  <Name xml:lang="en">Home Server</Name>
<Term termID="14.1">
  <Name xml:lang="en">Media Server</Name>
</Term>
<Term termID="14.2">
  <Name xml:lang="en">Refrigerator HS</Name>
</Term>
<Term termID="14.3">
  <Name xml:lang="en">Game machine HS</Name>

```

```

    </Term>
  </Term>
</ClassificationScheme>

```

A.13 Place Type CS

The following classification scheme defines controlled terms for "NameTerm" of "mpeg7:PlaceType" used in the "Location" of "NaturalEnvironmentInformationTableType".

```

<?xml version="1.0" encoding="UTF-8"?>
<ClassificationScheme uri="urn:tva:metadata:extended:cs:PlaceTypeCS:2011">
  <Term termID="1">
    <Name xml:lang="en">My Home</Name>
    <Definition xml:lang="en">
      A place where a person lives or a place to go back
    </Definition>
  </Term>
  <Term termID="2">
    <Name xml:lang="en">Transportation Facilities</Name>
    <Definition xml:lang="en">
      A place where people access transportation means
    </Definition>
    <Term termID="2.1">
      <Name xml:lang="en">Station</Name>
    </Term>
    <Term termID="2.2">
      <Name xml:lang="en">Stop</Name>
    </Term>
    <Term termID="2.3">
      <Name xml:lang="en">Airport</Name>
    </Term>
    <Term termID="2.4">
      <Name xml:lang="en">Harbour</Name>
    </Term>
  </Term>
  <Term termID="3">
    <Name xml:lang="en">Traffic Facilities</Name>
    <Definition xml:lang="en">
      A place where people access by using traffic means
    </Definition>
    <Term termID="3.1">
      <Name xml:lang="en">Entrance</Name>
    </Term>
    <Term termID="3.2">
      <Name xml:lang="en">Parking</Name>
    </Term>
    <Term termID="3.3">
      <Name xml:lang="en">Crossing</Name>
    </Term>
    <Term termID="3.4">
      <Name xml:lang="en">Street</Name>
    </Term>
    <Term termID="3.5">
      <Name xml:lang="en">Gas Station</Name>
    </Term>
    <Term termID="3.6">
      <Name xml:lang="en">Highway</Name>
    </Term>
    <Term termID="3.7">
      <Name xml:lang="en">Interchange</Name>
    </Term>
    <Term termID="3.8">
      <Name xml:lang="en">Service Area</Name>
    </Term>
  </Term>
  <Term termID="4">
    <Name xml:lang="en">Work Place</Name>
    <Definition xml:lang="en">
      A place where people work
    </Definition>
    <Term termID="4.1">
      <Name xml:lang="en">Office</Name>
    </Term>
  </Term>

```

```

<Term termID="4.2">
  <Name xml:lang="en">Factory</Name>
</Term>
<Term termID="4.3">
  <Name xml:lang="en">Studio</Name>
</Term>
<Term termID="4.4">
  <Name xml:lang="en">Outdoor</Name>
</Term>
</Term>
<Term termID="5">
  <Name xml:lang="en">School</Name>
  <Definition xml:lang="en">
    A place where a person goes to study
  </Definition>
<Term termID="5.1">
  <Name xml:lang="en">University</Name>
</Term>
<Term termID="5.2">
  <Name xml:lang="en">High School</Name>
</Term>
<Term termID="5.3">
  <Name xml:lang="en">Kindergarten</Name>
</Term>
</Term>
<Term termID="6">
  <Name xml:lang="en">Hall</Name>
  <Definition xml:lang="en">
    A place or building used for meeting, entertainment, exhibition, etc.
  </Definition>
<Term termID="6.1">
  <Name xml:lang="en">Museum</Name>
</Term>
<Term termID="6.2">
  <Name xml:lang="en">Library</Name>
</Term>
<Term termID="6.3">
  <Name xml:lang="en">Theatre</Name>
</Term>
</Term>
<Term termID="7">
  <Name xml:lang="en">Public Facilities</Name>
  <Definition xml:lang="en">
    A place or building for public service
  </Definition>
<Term termID="7.1">
  <Name xml:lang="en">Bank</Name>
</Term>
<Term termID="7.2">
  <Name xml:lang="en">Post Office</Name>
</Term>
<Term termID="7.3">
  <Name xml:lang="en">Hospital</Name>
</Term>
<Term termID="7.4">
  <Name xml:lang="en">Police</Name>
</Term>
<Term termID="7.5">
  <Name xml:lang="en">Public Office</Name>
</Term>
<Term termID="7.6">
  <Name xml:lang="en">Fire-Brigade Station</Name>
</Term>
</Term>
<Term termID="8">
  <Name xml:lang="en">Historic Site</Name>
  <Definition xml:lang="en">
    A place or building of historic interest and value
  </Definition>
<Term termID="8.1">
  <Name xml:lang="en">Palace</Name>
</Term>
<Term termID="8.2">
  <Name xml:lang="en">Castle</Name>
</Term>
<Term termID="8.3">
  <Name xml:lang="en">Church</Name>
</Term>

```

```

<Term termID="8.4">
  <Name xml:lang="en">Temple</Name>
</Term>
<Term termID="8.5">
  <Name xml:lang="en">Shrine</Name>
</Term>
<Term termID="8.6">
  <Name xml:lang="en">Graveyard</Name>
</Term>
</Term>
<Term termID="9">
  <Name xml:lang="en">Natural Outdoor Spot</Name>
  <Definition xml:lang="en">
    A spot of natural or outdoor environment
  </Definition>
  <Term termID="9.1">
    <Name xml:lang="en">Mountain</Name>
  </Term>
  <Term termID="9.2">
    <Name xml:lang="en">Sea</Name>
  </Term>
  <Term termID="9.3">
    <Name xml:lang="en">Lake</Name>
  </Term>
  <Term termID="9.4">
    <Name xml:lang="en">Pond</Name>
  </Term>
  <Term termID="9.5">
    <Name xml:lang="en">River</Name>
  </Term>
  <Term termID="9.6">
    <Name xml:lang="en">Valley</Name>
  </Term>
  <Term termID="9.7">
    <Name xml:lang="en">Field</Name>
  </Term>
  <Term termID="9.8">
    <Name xml:lang="en">Island</Name>
  </Term>
  <Term termID="9.9">
    <Name xml:lang="en">Sky</Name>
  </Term>
</Term>
<Term termID="10">
  <Name xml:lang="en">Hotel</Name>
  <Definition xml:lang="en">
    A building or place where people stay, sleep or take a rest
  </Definition>
</Term>
<Term termID="11">
  <Name xml:lang="en">Restaurant</Name>
  <Definition xml:lang="en">
    A building or place where foods are served and people can eat
  </Definition>
</Term>
<Term termID="12">
  <Name xml:lang="en">Shopping Spot</Name>
  <Definition xml:lang="en">
    A building or place where people go shopping
  </Definition>
  <Term termID="12.1">
    <Name xml:lang="en">Department Store</Name>
  </Term>
  <Term termID="12.2">
    <Name xml:lang="en">Supermarket</Name>
  </Term>
  <Term termID="12.3">
    <Name xml:lang="en">Shop</Name>
  </Term>
</Term>
<Term termID="13">
  <Name xml:lang="en">Leisure Spot</Name>
  <Definition xml:lang="en">
    A place where people enjoy leisure
  </Definition>
  <Term termID="13.1">
    <Name xml:lang="en">Park</Name>
  </Term>

```

```

<Term termID="13.2">
  <Name xml:lang="en">Garden</Name>
</Term>
<Term termID="13.3">
  <Name xml:lang="en">Amusement Park</Name>
</Term>
<Term termID="13.4">
  <Name xml:lang="en">Resort</Name>
</Term>
<Term termID="13.5">
  <Name xml:lang="en">Hot Spring</Name>
</Term>
</Term>
<Term termID="14">
  <Name xml:lang="en">Sports Spot</Name>
  <Definition xml:lang="en">
    A place where people enjoy sports
  </Definition>
  <Term termID="14.1">
    <Name xml:lang="en">Stadium</Name>
  </Term>
  <Term termID="14.2">
    <Name xml:lang="en">Sports Gym</Name>
  </Term>
  <Term termID="14.3">
    <Name xml:lang="en">Tennis Court</Name>
  </Term>
  <Term termID="14.4">
    <Name xml:lang="en">Golf Course</Name>
  </Term>
  <Term termID="14.5">
    <Name xml:lang="en">Swimming Pool</Name>
  </Term>
  <Term termID="14.6">
    <Name xml:lang="en">Skiing Ground</Name>
  </Term>
  <Term termID="14.7">
    <Name xml:lang="en">Skating Rink</Name>
  </Term>
</Term>
<Term termID="15">
  <Name xml:lang="en">Mobility</Name>
  <Definition xml:lang="en">
    The user is in move.
  </Definition>
  <Term termID="15.1">
    <Name xml:lang="en">In Transportation</Name>
    <Term termID="15.1.1">
      <Name xml:lang="en">In Car</Name>
    </Term>
    <Term termID="15.1.2">
      <Name xml:lang="en">In Train</Name>
    </Term>
    <Term termID="15.1.3">
      <Name xml:lang="en">In Airplane</Name>
    </Term>
  </Term>
  <Term termID="15.2">
    <Name xml:lang="en">On Foot</Name>
    <Term termID="15.2.1">
      <Name xml:lang="en">Walking</Name>
    </Term>
    <Term termID="15.2.2">
      <Name xml:lang="en">Running</Name>
    </Term>
  </Term>
</Term>
</ClassificationScheme>

```

A.14 Weather Type CS

The following classification scheme defines controlled terms for "Weather" of "NaturalEnvironmentInformationTableType".

```
<?xml version="1.0" encoding="UTF-8"?>
<ClassificationScheme uri="urn:tva:metadata:extended:cs:WeatherTypeCS:2011">
  <Term termID="1">
    <Name xml:lang="en">Spring</Name>
    <Definition xml:lang="en">
      The season between winter and summer in which leaves and flowers appear.
    </Definition>
  </Term>
  <Term termID="2">
    <Name xml:lang="en">Summer</Name>
    <Definition xml:lang="en">
      The season between spring and autumn when the sun is hot and there are many flower.
    </Definition>
  </Term>
  <Term termID="3">
    <Name xml:lang="en">Autumn</Name>
    <Definition xml:lang="en">
      The season between summer and winter when leaves turn gold and fruits become ripe.
    </Definition>
  </Term>
  <Term termID="4">
    <Name xml:lang="en">Winter</Name>
    <Definition xml:lang="en">
      The season between autumn and spring when it is cold and most trees have lost their leaves.
    </Definition>
  </Term>
  <Term termID="5">
    <Name xml:lang="en">Sunny</Name>
    <Definition xml:lang="en">
      Having bright sunlight.
    </Definition>
  </Term>
  <Term termID="6">
    <Name xml:lang="en">Rainy</Name>
    <Definition xml:lang="en">
      Having a lot of rain.
    </Definition>
  </Term>
  <Term termID="7">
    <Name xml:lang="en">Cloudy</Name>
    <Definition xml:lang="en">
      Full of clouds.
    </Definition>
  </Term>
  <Term termID="8">
    <Name xml:lang="en">Snowy</Name>
    <Definition xml:lang="en">
      Full of snow or snowing.
    </Definition>
  </Term>
  <Term termID="9">
    <Name xml:lang="en">Windy</Name>
    <Definition xml:lang="en">
      With a lot of wind.
    </Definition>
  </Term>
  <Term termID="10">
    <Name xml:lang="en">Foggy</Name>
    <Definition xml:lang="en">
      With a lot of fog.
    </Definition>
  </Term>
  <Term termID="11">
    <Name xml:lang="en">Frosty</Name>
    <Definition xml:lang="en">
      With a lot of frost.
    </Definition>
  </Term>
  <Term termID="12">
    <Name xml:lang="en">Storm</Name>
    <Definition xml:lang="en">
```

```

    A rough weather condition with wind, rain, and often lightning.
  </Definition>
  <Term termID="12.1">
    <Name xml:lang="en">ThunderStorm</Name>
  </Term>
  <Term termID="12.2">
    <Name xml:lang="en">RainStorm</Name>
  </Term>
  <Term termID="12.3">
    <Name xml:lang="en">SnowStorm</Name>
  </Term>
</Term>
<Term termID="13">
  <Name xml:lang="en">Extreme Weather</Name>
  <Term termID="13.1">
    <Name xml:lang="en">Hurricane</Name>
  </Term>
  <Term termID="13.2">
    <Name xml:lang="en">Typhoon</Name>
  </Term>
  <Term termID="13.3">
    <Name xml:lang="en">Tornado</Name>
  </Term>
</Term>
</ClassificationScheme>

```

A.15 Temporal Relation CS

The following classification scheme defines controlled terms for temporal relations between items and/or components.

```

<?xml version="1.0" encoding="UTF-8"?>
<ClassificationScheme uri="urn:tva:metadata:extended:cs:TemporalRelationCS:2005">
  <!-- ##### -->
  <!-- TEMPORAL RELATION -->
  <!-- Definition: This is a set of terms used within Content Packaging to -->
  <!-- indicate -->
  <!-- what kinds of temporal relation components/items have with others -->
  <!-- It makes the receiving terminal know when the component and/or item -->
  <!-- has to be consumed -->
  <!-- ##### -->
  <Term termID="precedes">
    <Name xml:lang="en">precedes</Name>
    <Definition> B precedes C if and only if B ends before C starts.</Definition>
  </Term>
  <Term termID="follows">
    <Name xml:lang="en">follows</Name>
    <Definition> Inverse relation of precedes </Definition>
  </Term>
  <Term termID="meets">
    <Name xml:lang="en">meets</Name>
    <Definition>B meets C if and only if B ends at the same time as C starts.</Definition>
  </Term>
  <Term termID="metBy">
    <Name xml:lang="en">metBy</Name>
    <Definition> Inverse relation of meets </Definition>
  </Term>
  <Term termID="overlaps">
    <Name xml:lang="en">overlaps</Name>
    <Definition>B overlaps C if and only if B starts before C starts, B ends after C starts and B
ends before C ends.</Definition>
  </Term>
  <Term termID="overlappedBy">
    <Name xml:lang="en">overlappedBy</Name>
    <Definition> Inverse relation of overlaps </Definition>
  </Term>
  <Term termID="contains">
    <Name xml:lang="en">contains</Name>
    <Definition>
      B contains C if and only if C starts after B starts and C ends at the same time as or
before B ends, or C starts after or at the same time as B starts and C ends before B ends.
    </Definition>
  </Term>
  <Term termID="during">

```

```

    <Name xml:lang="en">during</Name>
    <Definition> Inverse relation of contains </Definition>
  </Term>
  <Term termID="strictContains">
    <Name xml:lang="en">strictContains</Name>
    <Definition>B strictContains C if and only if C starts after B starts and C ends before B
ends.</Definition>
  </Term>
  <Term termID="strictDuring">
    <Name xml:lang="en">strictDuring</Name>
    <Definition> Inverse relation of strictContains </Definition>
  </Term>
  <Term termID="starts">
    <Name xml:lang="en">starts</Name>
    <Definition>B starts C if and only if B starts at the same time as C starts and B ends before
C ends.</Definition>
  </Term>
  <Term termID="startedBy">
    <Name xml:lang="en">startedBy</Name>
    <Definition> Inverse relation of starts </Definition>
  </Term>
  <Term termID="finishes">
    <Name xml:lang="en">finishes</Name>
    <Definition>B finishes C if and only if B starts after C starts and B ends at the same time as
C ends.</Definition>
  </Term>
  <Term termID="finishedBy">
    <Name xml:lang="en">finishedBy</Name>
    <Definition> Inverse relation of finishes </Definition>
  </Term>
  <Term termID="coOccurs">
    <Name xml:lang="en">coOccurs</Name>
    <Definition>B coOccurs if and only if B starts at the same time as C starts and B ends at the
same time as C ends.</Definition>
  </Term>
  <Term termID="contiguous">
    <Name xml:lang="en">contiguous</Name>
    <Definition>A1, A2, ... An contiguous if and only if they are temporally disjoint and
connected.</Definition>
  </Term>
  <Term termID="sequential">
    <Name xml:lang="en">sequential</Name>
    <Definition>A1, A2, ... An sequential if and only if they are temporally disjoint and not
necessarily connected.</Definition>
  </Term>
  <Term termID="coBegin">
    <Name xml:lang="en">coBegin</Name>
    <Definition>A1, A2, ... An coBegin if and only if they start at the same time.</Definition>
  </Term>
  <Term termID="coEnd">
    <Name xml:lang="en">coEnd</Name>
    <Definition>A1, A2, ... An coEnd if and only if they end at the same time.</Definition>
  </Term>
  <Term termID="parallel">
    <Name xml:lang="en">parallel</Name>
    <Definition>A1, A2, ... An parallel if and only if the intersection of A1, A2, ... An has one non-
empty interior.</Definition>
  </Term>
  <Term termID="overlapping">
    <Name xml:lang="en">overlapping</Name>
    <Definition>
      A1, A2, ... An overlapping if and only if the union of A1, A2, ... An is connected and each Ai
intersects at least one other Aj with non-empty interior.
    </Definition>
  </Term>
</ClassificationScheme>

```

A.16 Spatial Relation CS

The following classification scheme defines controlled terms for spatial relations between items and/or components.

```

<?xml version="1.0" encoding="UTF-8"?>
<ClassificationScheme uri="urn:tva:metadata:extended:cs:SpatialRelationCS:2005">
  <Term termID="south">
    <Name xml:lang="en">south</Name>
    <Definition>
      B south C if and only if, in the dimension x, B starts after or at the same time as C starts and B ends at the same time as or before C ends, or B starts at the same time as or before C starts and B ends after or at the same time as C ends; and, in the dimension y, B ends at the same time as or before C starts.
    </Definition>
  </Term>
  <Term termID="north">
    <Name xml:lang="en">north</Name>
    <Definition> Inverse relation of south </Definition>
  </Term>
  <Term termID="west">
    <Name xml:lang="en">west</Name>
    <Definition>
      B west C if and only if, in the dimension x, B ends at the same time as or before C starts; and, in the dimension y, B starts after or at the same time as C starts and B ends at the same time as or before C ends, or B starts at the same time as or before C starts and B ends after or at the same time as C ends.
    </Definition>
  </Term>
  <Term termID="east">
    <Name xml:lang="en">east</Name>
    <Definition> Inverse relation of west </Definition>
  </Term>
  <Term termID="northwest">
    <Name xml:lang="en">northwest</Name>
    <Definition>
      B northwest C if and only if, in the dimension x, B ends at the same time as or before C starts; and, in the dimension y, B starts after or at the same time as C ends.
    </Definition>
  </Term>
  <Term termID="southeast">
    <Name xml:lang="en">southeast</Name>
    <Definition> Inverse relation of northwest </Definition>
  </Term>
  <Term termID="southwest">
    <Name xml:lang="en">southwest</Name>
    <Definition>
      B southwest C if and only if, in the dimension x, B ends at the same time as or before C starts; and, in the dimension y, B ends at the same time as or before C starts.
    </Definition>
  </Term>
  <Term termID="northeast">
    <Name xml:lang="en">northeast</Name>
    <Definition> Inverse relation of southwest </Definition>
  </Term>
  <Term termID="left">
    <Name xml:lang="en">left</Name>
    <Definition>
      B left C if and only if, in the dimension x, B ends at the same time as or before C starts.
    </Definition>
  </Term>
  <Term termID="right">
    <Name xml:lang="en">right</Name>
    <Definition> Inverse relation of left </Definition>
  </Term>
  <Term termID="below">
    <Name xml:lang="en">below</Name>
    <Definition>
      B below C if and only if, in the dimension y, B ends at the same time as or before C starts.
    </Definition>
  </Term>
  <Term termID="above">
    <Name xml:lang="en">above</Name>
    <Definition> Inverse relation of below </Definition>
  </Term>
  <Term termID="over">

```

```

    <Name xml:lang="en">over</Name>
    <Definition>
      B over C if and only if, in the dimension x, B starts at the same time as or before C
      starts and B ends after C starts, or B starts after C starts and B starts before C ends; and, in the
      dimension y, B starts at the same time as C ends.
    </Definition>
  </Term>
  <Term termID="under">
    <Name xml:lang="en">under</Name>
    <Definition> Inverse relation of over </Definition>
  </Term>
  <Term termID="equals">
    <Name xml:lang="en">equals</Name>
    <Definition>B equals C if and only if B is equal to C.</Definition>
  </Term>
  <Term termID="inside">
    <Name xml:lang="en">inside</Name>
    <Definition>B1, B2, ..., Bn is inside C if and only if the union of B1, ..., Bn is a subset of
  C</Definition>
  </Term>
  <Term termID="contains">
    <Name xml:lang="en">contains</Name>
    <Definition> Inverse relation of inside </Definition>
  </Term>
  <Term termID="covers">
    <Name xml:lang="en">covers</Name>
    <Definition>B1, B2, ..., Bn covers argument C if and only if the union of B1, B2, ..., Bn
  contains C AND that union is not equal to C</Definition>
  </Term>
  <Term termID="coveredBy">
    <Name xml:lang="en">coveredBy</Name>
    <Definition> Inverse relation of covers </Definition>
  </Term>
  <Term termID="overlaps">
    <Name xml:lang="en">overlaps</Name>
    <Definition>B overlaps C if and only if B intersect C has non-empty interior</Definition>
  </Term>
  <Term termID="touches">
    <Name xml:lang="en">touches</Name>
    <Definition>B1, B2, ..., Bn touches argument C if and only if B union C is
  connected</Definition>
  </Term>
  <Term termID="disjoint">
    <Name xml:lang="en">disjoint</Name>
    <Definition>B is disjoint with C if and only if the intersection of B and C is
  empty.</Definition>
  </Term>
  <Term termID="separated">
    <Name xml:lang="en">separated</Name>
    <Definition>E is separated from O if and only if the intersection of E and the closure of A is
  empty AND the intersection of the closure of
      E with O is empty.
    </Definition>
  </Term>
</ClassificationScheme>

```

A.17 Content Type CS

The following classification scheme defines controlled terms for content types.

```

<?xml version="1.0" encoding="UTF-8"?>
<ClassificationScheme uri=" urn:tva:metadata:extended:cs:ContentTypeCS:2005">
  <!-- ##### -->
  <!-- ContentTypeCS -->
  <!-- Definition: This is a set of terms used to indicate what kinds of content are -->
  <!-- used as main Program or used in Package. -->
  <!-- Content can be classified by either the type of content or the subject of content -->
  <!-- ##### -->
  <Term termID="1">
    <Name xml:lang="en">Audio</Name>
  </Term>
  <Term termID="2">
    <Name xml:lang="en">Video</Name>
  </Term>

```

```

</Term>
<Term termID="3">
  <Name xml:lang="en">StillImage</Name>
</Term>
<Term termID="4">
  <Name xml:lang="en">Text</Name>
</Term>
<Term termID="5">
  <Name xml:lang="en">DataBroadcasting</Name>
</Term>
<Term termID="6">
  <Name xml:lang="en">Interstitial</Name>
</Term>
<Term termID="7">
  <Name xml:lang="en">Education</Name>
</Term>
<Term termID="8">
  <Name xml:lang="en">Application</Name>
</Term>
<Term termID="9">
  <Name xml:lang="en">Game</Name>
</Term>
<Term termID="10">
  <Name xml:lang="en">Package</Name>
</Term>
</ClassificationScheme>

```

A.18 Checksum Algorithm CS

```

<?xml version="1.0" encoding="UTF-8"?>
<ClassificationScheme uri="urn:tva:metadata:cs:ChecksumAlgorithmCS:2008">
  <!-- ##### -->
  <!-- ChecksumAlgorithmCS -->
  <!-- ##### -->
  <!-- -->
  <!-- Cyclic Redundancy Checksums -->
  <Term termID="crc16">
    <Name xml:lang="en">CRC16 (ITU-T)</Name>
    <Definition xml:lang="en">As specified by CCITT/ITU-T and used by X.25, V.41, Bluetooth, PPP, IrDA.
    Polynomial:  $x^{16} + x^{12} + x^5 + 1$ </Definition>
  </Term>
  <Term termID="crc32">
    <Name xml:lang="en">CRC32 (MPEG-2)</Name>
    <Definition xml:lang="en">As specified in IEEE 802.3, ITU-T Recommendation V.42 and MPEG-2.
    Polynomial:  $x^{32} + x^{26} + x^{23} + x^{22} + x^{16} + x^{12} + x^{11} + x^{10} + x^8 + x^7 + x^5 + x^4 + x^2 + x + 1$ </Definition>
  </Term>
  <Term termID="crc64">
    <Name xml:lang="en">CRC64 (ISO)</Name>
    <Definition xml:lang="en">As specified in ISO 3309 for use by HDLC.
    Polynomial:  $x^{64} + x^4 + x^3 + x + 1$ </Definition>
  </Term>
  <Term termID="crc64-ecma">
    <Name xml:lang="en">CRC64 (ECMA)</Name>
    <Definition xml:lang="en">As specified in ECMA-182.
    Polynomial:  $x^{64} + x^{62} + x^{57} + x^{55} + x^{54} + x^{53} + x^{52} + x^{47} + x^{46} + x^{45} + x^{40} + x^{39} + x^{38} + x^{37} + x^{35} + x^{33} + x^{32} + x^{31} + x^{29} + x^{27} + x^{24} + x^{23} + x^{22} + x^{21} + x^{19} + x^{17} + x^{13} + x^{12} + x^{10} + x^9 + x^7 + x^4 + x + 1$ </Definition>
  </Term>
  <!-- -->
  <!-- Cryptographic hash functions -->
  <Term termID="md5">
    <Name xml:lang="en">MD5</Name>
    <Definition xml:lang="en">Message-Digest algorithm 5, a 128-bit hash designed at MIT by Professor Ronald Rivest.</Definition>
  </Term>
  <Term termID="sha1">
    <Name xml:lang="en">SHA-1</Name>
    <Definition xml:lang="en">160-bit Secure Hash Algorithm, developed by the United States National Security Agency and published by NIST.</Definition>
  </Term>
</ClassificationScheme>

```

Annex B (normative): *TV-Anytime* extended description schemes and classification schemes

The *TV-Anytime* extended metadata schema listed in the present document has been aggregated into a series of xsd files, forming the reference documentation, contained in archive ts_1028220303v010601p0.zip, which accompanies the present document.

- "tva_mpeg21_2012.xsd";
- "tva_metadata_3-3_v161.xsd".

The following classification schemes are also attached as xml files in archive ts_1028220303v010601p0.zip, which accompanies the present document:

- AccessibilityCS.
- ChecksumAlgorithmCS.
- ContentTypeCS.
- CPUTypeCS.
- EducationalUseCS.
- FamilyMemberCS.
- GamePerspectivesCS.
- IntendedEducationalUserCS.
- MiddlewareServiceCS.
- OperatingSystemCS.
- OtherSystemSoftwareCS.
- PlaceTypeCS.
- SpatialRelationCS.
- TemporalRelationCS.
- TerminalTypeCS.
- VirtualMachineCS.
- WeatherTypeCS.

The extended metadata schema imports other files that need to be present in order to be valid:

- "tva_mpeg7_2008.xsd" that is available in archive ts_1028220301v010801p0.zip accompanying TS 102 822-3-1 [3];
- "tva_metadata_3-1_v181.xsd" that is available in archive ts_1028220301v010801p0.zip accompanying TS 102 822-3-1 [3];
- "tva_interstitial_3-4_v161.xsd" that is available in archive ts_1028220304v010601p0.zip accompanying TS 102 822-3-4 [5];
- xml.xsd that is available in archive ts_1028220301v010801p0.zip accompanying TS 102 822-3-1 [3];
- "tva_rmpi_5-1_v171.xsd" that is available in archive ts_1028220501v010701p0.zip can be extracted from TS 102 822-5-1 [7].

List of figures

Figure 1: Metadata and content flow	12
Figure 2: Basic entity-relation graph syntax.....	14
Figure 3: Content package data model	50
Figure 4: Temporal relations between items and components	58

History

Document history		
V1.1.1	January 2006	Publication
V1.2.1	November 2007	Publication
V1.3.1	May 2009	Publication
V1.4.1	July 2010	Publication
V1.5.1	November 2011	Publication
V1.6.1	December 2012	Publication